



2024 Basic Club & Competition Rules



CONTENTS

1.	GOVERNING RULES & EVENT STRUCTURE	4
1.1.	CHUMPCAR INTERNATIONAL INC. DBA CHAMPCAR ENDURANCE SERIES.....	4
1.2.	SANCTIONING BODY OPERATIONS.....	4
1.3.	CHAMPCAR GENERAL RULES	4
1.4.	WINNERS AND AWARDS.....	5
1.5.	NATIONAL CHAMPIONSHIP	6
1.6.	NATIONAL CHAMPIONSHIP POINTS SYSTEM.....	6
2.	ELIGIBILITY	7
2.1.	DEFINITION OF A 500 POINT CHAMPCAR.....	7
2.2.	DEFINITION OF AN EXCEPTION CLASS (“EC”) CAR.....	7
2.3.	ENDURANCE RACING CAR CLASSIFICATIONS.....	7
2.4.	DRIVER AND CREW ELIGIBILITY AND LICENSING	8
3.	SAFETY SYSTEMS	10
3.1.	ROLL-CAGES AND SUPPORTING STRUCTURE	10
3.2.	ROLL CAGE DESIGN	10
3.3.	DRIVER’S SEAT.....	15
3.4.	RACING HARNESSSES	16
3.5.	WINDOW NETS / ARM-RESTRAINTS.....	17
3.6.	DRIVER EGRESS	18
3.7.	STEERING WHEEL LOCKS	18
3.8.	AIRBAGS.....	18
3.9.	ONBOARD FIRE EXTINGUISHER.....	18
3.10.	DRIVER’S HELMET	19
3.11.	NECK RESTRAINT SYSTEM.....	19
3.12.	FIRE RETARDANT CLOTHING.....	19
3.13.	ANNUAL GEAR CHECK	20
3.14.	BATTERIES.....	20
3.15.	MASTER ELECTRICAL KILL (CUT-OFF) SWITCH.....	20
3.16.	TOW HOOK	21
3.17.	DRIVE SHAFT	21
4.	VEHICLE VALUE.....	22
4.1.	TOTAL POINT VALUE	22
4.2.	VEHICLE PERFORMANCE INDEX	22
4.3.	FIXED POINTS.....	22
4.4.	NON FIXED POINT VALUE PARTS.....	25
4.5.	ENGINE SWAP	25
4.6.	PLATFORM SWAP.....	26
4.7.	OTHER EQUIPMENT THAT DOES NOT COUNT TOWARD THE TOTAL POINT VALUE	26
4.8.	TIRE SPECIFICATIONS FOR ALL CLASSES	28
5.	SAFETY & TECHNICAL INSPECTIONS AND RELATED PENALTIES.....	29
5.1.	INSPECTION PROCESS.....	29
5.2.	TECHNICAL INSPECTION	29
5.3.	PENALTIES.....	29
5.4.	POST-RACE IMPOUND AND INSPECTION.....	30
5.5.	PROTESTS.....	30
5.6.	DAY TWO HANDICAP	31
6.	ENTRIES AND TEAMS	32
6.1.	ENTRY APPLICATIONS & PAYMENT DEADLINES	32
6.2.	ENTRY & DRIVER FEES	32
6.3.	CATASTROPHIC FAILURE DISCOUNT.....	32
6.4.	MINIMUM DRIVER ENTRIES PER CAR.....	32

7.	RULES OF THE ROAD.....	33
7.1.	MAXIMUM DRIVING TIME.....	33
7.2.	ON-TRACK DRIVER CONDUCT.....	33
7.3.	STOPPING ON COURSE.....	33
7.4.	PIT IN: UNSAFE DRIVER CONDITION.....	33
7.5.	PASSENGERS.....	33
8.	RULES OF THE PIT.....	34
8.1.	PIT AND/OR PADDOCK AREA.....	34
8.2.	PIT STOPS AND FUELING OF VEHICLES.....	34
8.3.	PIT STOPS AND TIRE CHANGES.....	35
9.	MECHANICAL & ELECTRICAL SYSTEMS, ASSEMBLIES, COMPONENTS.....	37
9.1.	GLASS – GENERAL.....	37
9.2.	WINDSHIELDS.....	37
9.3.	SIDE & REAR WINDOWS.....	37
9.4.	NERF BARS OR EXO-SKELETON.....	38
9.5.	BODY PANELS.....	38
9.6.	SUNROOFS, T-TOPS, CONVERTIBLES.....	38
9.7.	CAR NUMBERS, CLASS DESIGNATION AND VISIBILITY.....	38
9.8.	CHAMPCAR AND SPONSOR DECALS.....	39
9.9.	HEADLIGHTS, TAILLIGHTS, AND BRAKE LIGHTS.....	39
9.10.	FUEL SYSTEMS.....	41
9.11.	OIL CATCH TANKS, FILTERS, COOLERS, AND BREATHERS.....	42
9.12.	COOLANT.....	43
9.13.	EXHAUST.....	43
9.14.	NOISE LIMIT.....	43
9.15.	COCKPIT.....	43
9.16.	MIRRORS.....	43
9.17.	ENGINE FIREWALL.....	43
9.18.	CAMERA MOUNTS.....	43
9.19.	COOL SUITS AND DRINKING SYSTEMS.....	44
9.20.	BALLAST.....	44
9.21.	BUMPER BARS / BASH BARS.....	44
9.22.	AERODYNAMIC DEVICES.....	44
	APPENDIX 1 – AERODYNAMIC ANATOMY.....	45
	APPENDIX 2 – CHASSIS MODIFICATION GUIDE.....	46
	APPENDIX 3 – LEGAL.....	47
	APPENDIX 4 – BELT INSTALL.....	48
	APPENDIX 5 – ROLL CAGE.....	51
	APPENDIX 6 – DECAL PLACEMENT.....	52
	APPENDIX 7 – TRANSPONDER.....	53
	APPENDIX 8 – FLAGS.....	54
	APPENDIX 9 – FLAGTRONICS.....	55
	CHAMPCAR MISSION STATEMENT.....	56

1. GOVERNING RULES & EVENT STRUCTURE

1.1. CHUMPCAR INTERNATIONAL INC. DBA CHAMPCAR ENDURANCE SERIES

- 1.1.1. ChumpCar International Inc. is a membership organization (“Social Club”) doing business as (DBA) the ‘ChampCar Endurance Series’.
- 1.1.2. ChumpCar International / ChampCar Endurance Series Membership: Membership is open to ALL, without restriction. Full membership in ChampCar requires an annual dues payment and is valid 12 months from the date of purchase. Full members shall be issued a membership number and a printable membership card. Event memberships are also available. Event members will purchase a temporary membership at the track that will be valid only for the duration of the event for which the membership was purchased, and this member will not have the voting rights of the full member.

1.2. SANCTIONING BODY OPERATIONS

- 1.2.1. ChampCar shall adhere to the Basic Club & Competition Rules (BCCR)
- 1.2.2. The BCCR shall govern all ChampCar events sanctioned by ChampCar. ChampCar may revise the BCCR or issue supplements to it and all rules stated herein may be amended at any given time in writing or verbally at any event (and put into writing at a later time) at the sole discretion of ChampCar based on maintaining safety, equity in competition, cost reduction, or clarification. The interpretation and application of the ChampCar BCCR by ChampCar officials shall be final and binding.
- 1.2.3. All Members of ChampCar International Inc. shall uphold the Basic Club & Competition Rules (BCCR) in order to promote, elevate and enhance the name, brand and reputation of the organization, including its staff, Board of Directors, sponsors, and all those affiliated in any way with the ChampCar Endurance Series. Any act that is ruled to be detrimental to the organization, as determined by the Club’s Board of Directors, may result in an action by the Board.

1.3. CHAMPCAR GENERAL RULES

- 1.3.1. Release and Acknowledgment Forms: Members must sign a ChampCar release, annual gear waiver, and acknowledgment agreement.
- 1.3.2. Event Credential: All drivers and crew (“crew” includes all non-driving attendees, including but not limited to, family, friends, and invited guests) are required to obtain a color-coded wristband from ChampCar at registration. Track restrictions shall take precedence over ChampCar general access allowances.
- 1.3.3. WARNING: This is racing. Racing is dangerous. Your car may be damaged or destroyed at any time. You may be injured or killed. Do not participate in a race, in any capacity, if you do not understand this and do not get into a race car without thinking about this.
- 1.3.4. Insurance: ChampCar carries and provides insurance for facility and event liability; however, ChampCar is NOT your primary health insurance provider. ALL COMPETITORS MUST HAVE PERSONAL HEALTH AND/OR MEDICAL INSURANCE TO COVER THEIR MEDICAL NEEDS (ambulance transport, initial medical screening, etc.). YOU SHOULD NOT BE ENGAGED IN DANGEROUS ACTIVITIES SUCH AS AUTO RACING IF YOU DO NOT HAVE ADEQUATE PERSONAL HEALTH INSURANCE PROTECTION. PARTICIPANTS THAT DO NOT HAVE INSURANCE WILL BE

PERSONALLY LIABLE FOR FINANCIAL CHARGES AND FEES ASSOCIATED WITH ANY MEDICAL CARE.

- 1.3.5. Organizer Decisions: ChampCar decisions are final and are not up for discussion, negotiation, definition, or argument.
- 1.3.6. Unsafe Vehicles: At ChampCar's sole discretion, any car may be determined unsafe for competition and may be removed from the event at any time.
- 1.3.7. Unsafe Drivers: At ChampCar's sole discretion, any driver may be determined unsafe for competition and may be removed from the event at any time.
- 1.3.8. Disqualification from Race: If you have hidden, or concealed anything on your car that is illegal in anyway, OR violated ChampCar's rules, OR failed to meet the spirit and/or intent of ChampCar's rules, or you have seriously and repeatedly violated the event's driving safety rules, your car may be disqualified from the event. The act of disqualifying any car may occur at any time. Notification shall be issued by a ChampCar official to the Team Manager (or another representative).
- 1.3.9. Track Damage Liability: Teams entered in ANY ChampCar event shall be liable for any and all damage their car may have caused to the race track, race track safety barriers and/or race track equipment.
- 1.3.10. Event Changes: ChampCar reserves the right to cancel and/or alter the location, date(s), format, length, credits, and/or schedule of any event based on conditions, circumstances or matters that are beyond the control of ChampCar, or for any reason whatsoever. This may include, but is not limited to weather, track safety condition, car count/entry participation, track surface conditions, or changes issued under track contractual agreements that (in the opinion of ChampCar) would significantly detract from the overall safety, enjoyment, track time or services of the event.

1.4. WINNERS AND AWARDS

- 1.4.1. The car that completes the most laps (after all penalty laps and laps completed are tabulated) shall be declared the Winner.
- 1.4.2. Podium winning cars do NOT need to be running at the checkered flag.
- 1.4.3. ChampCar's world famous trophies will be awarded at ALL events, regardless of the number of entries.
 - 1.4.3.1. A "First Place in Class" trophy will be awarded to each class winner.
 - 1.4.3.2. A team representative MUST be present at the awards ceremony to collect any trophy or award.
- 1.4.4. Credits: Unless otherwise stated in the Supplemental Rules, all winnings shall be issued in Credits. Credits are exchangeable for and may be applied to any ChampCar event entry fee, transponder rental, or garage rental.
 - 1.4.4.1. Credits cannot be used to pay for track damage, ChampCar products, SWAG, or other fees. Credits MAY be bartered, or traded, or transferred.
 - 1.4.4.2. Credits shall be issued as an award in these amounts:
 - 1.4.4.2.1. For events 19-hours or longer: First Place \$1,400, Second Place \$1000, Third Place \$800. Total \$3,200.
 - 1.4.4.2.2. For events between 11-hours and 18-hours: First Place \$1200, Second Place \$800, Third Place \$600. Total \$2,600.

- 1.4.4.2.3. For events 10-hours or less: First Place \$800, Second Place \$600, and Third Place \$400. Total \$1,800 (Total \$3,600 for a Double-7 weekend)
- 1.4.4.2.4. For all events, fourth place \$200, 5th place \$100.
- 1.4.4.3. Credits may be accumulated.

1.5. NATIONAL CHAMPIONSHIP

- 1.5.1. An annual National Championship event will be held at a track designated by the CEO.
 - 1.5.1.1. In order to qualify for the National Championship, a ChampCar team must:
 - A. Finish in the top 75 in points for the previous season.
 - B. Teams must compete in at least two (2) event weekends.
 - 1.5.2. The winner of the National Championship:
 - A. All qualified teams carry their top two (2) season finish points into the Championship to be used for seeding purposes.
 - B. Championship is a winner take all event. Win the race to win the Championship.
 - 1.5.3. Bring the same car you raced to qualify for the Championship.
 - 1.5.3.1. If a Championship qualified car is totaled during the season, a replacement car can take its place in the Championship provided the new car is the same generation make, model and options as the original qualified car. The new car must be inspected by ChampCar tech and approved as the qualified replacement.
 - 1.5.4. A minimum of TWO (2) original team drivers from one or both qualifying races must complete at least one championship race lap.
 - 1.5.5. Championship events are NOT exclusive, anyone can enter.

1.6. NATIONAL CHAMPIONSHIP POINTS SYSTEM

- 1.6.1. One point per finishing position will be awarded to all competing teams. For example, 1 point for 1st, 2 points for 2nd, 3 points for 3rd, etc.
- 1.6.2. Points will be calculated based on the top two (2) finishes for each team. All other finishes will be dropped.

2. ELIGIBILITY

2.1. DEFINITION OF A 500 POINT CHAMPCAR

- 2.1.1. Race entry is limited to mass-produced (over 1,000 units), four-wheeled vehicles certified for US or Canadian street and highway use at the time of the vehicle's manufacture.
- 2.1.2. No kit cars.
- 2.1.3. All competing vehicles will be assigned a Vehicle Performance Index (VPI) by ChampCar. The Vehicle Performance Index is a point value that is based on the Performance Evaluation of your car. In order to compete for the overall win, all vehicles must maintain a total point value of 1000 points or less as described in Section 4 of the BCCR. Vehicles with total point values between 500 and 1000 points will receive penalty laps.
- 2.1.4. The vehicle's original, manufacturer-stated curb weight may not exceed 4,200 pounds.
- 2.1.5. The Event Director reserves the right to transfer ANY competition vehicle from the 500-point ChampCar classes to the Exception Class (EC) at ANY time. This rule shall only be invoked under extraordinary circumstances.

2.2. DEFINITION OF AN EXCEPTION CLASS ("EC") CAR

- 2.2.1. The Exception Class or "EC" car class is open to "ChampCar compatible" cars that wish to race with ChampCar but exceed the 1,000-point limit, or any team not wishing to compete for the overall win.
- 2.2.2. ChampCar reserves the right to deny entry to any EC car if ChampCar determines the car to be excessively superior in power, braking, top speed or other factors that ChampCar feels would be unsafe or disruptive to any event.
- 2.2.3. EC cars shall not be eligible for prize money or awards issued by ChampCar. However, when more than five (5) EC cars are entered in any one event, ChampCar may award separate EC class trophies.
- 2.2.4. EC vehicles must meet all ChampCar rules and regulations for vehicle eligibility.
- 2.2.5. EC cars will display in live timing during the race with an "EC" in front of their name. At the conclusion of the race, EC results will be uploaded separately from the ChampCar Podium results.

2.3. ENDURANCE RACING CAR CLASSIFICATIONS

- 2.3.1. Within ChampCar's endurance racing program there are six (6) classes of racing:
 - CLASS A – All cars with engine displacement of 1.91 liters and under
 - CLASS B – All cars with engine displacement between 1.92 liters and 2.4 liters
 - CLASS C – All cars with engine displacement between 2.41 liters and 3.91 liters
 - CLASS D – All cars with engine displacement of 3.92 liters and higher
 - CLASS EC – All exception class cars
 - CLASS F – All cars with a total as-raced VPI of 300 or less
- 2.3.2. A, B and C class vehicles with forced induction engines shall be classed in the next higher class (A -> B, B -> C, C ->D). Class D vehicles remain as Class D. e.g., a 2.2-liter turbocharged vehicle will be Class C.
- 2.3.3. Non-turbocharged rotary powered cars shall be placed in Class B. Factory turbocharged rotaries shall be placed in Class C.

- 2.3.4. Non EC Class cars are referred to as cars competing for the “ChampCar Podium.” The ChampCar Podium is for all cars competing under the Vehicle Performance Index (VPI) classification (see Section 4). The ChampCar Podium is for the top placing cars in the event, regardless of class.
- 2.3.5. Any car not on the VPI list must get Event Director approval to race and will run in EC class.
- 2.3.6. Class F cars are NOT in Class A through D. Teams wishing to compete for the Class F trophy must declare Class F prior to the race start and display the applicable Class F decals on their vehicle.

2.4. DRIVER AND CREW ELIGIBILITY AND LICENSING

- 2.4.1. All drivers must be ChampCar members.
- 2.4.2. All drivers must have a valid state-issued or international driver’s license
 - 2.4.2.1. Drivers without a state-issued or international driver’s license may be allowed to compete provided they can demonstrate extensive road racing experience with another sanctioning body (includes karting).
- 2.4.3. Novice, first-time road race competitors are required to attend a ChampCar driver’s school session. There is NO cost for the driver’s school.
 - 2.4.3.1. Definition of “NOVICE”: A novice (first-time road racing driver) is someone who has not competed in a ChampCar or other sanctioning body organized road racing event in the last 2 years and/or does not hold a valid competition license. Solo, autocross, drifting, club track-days, or HPDE events do not apply to competitive road racing experience, regardless of what license you may have.
 - 2.4.3.2. Driver schools are held after registration. Time and location to be announced in the event’s supplemental rules.
- 2.4.4. Drivers under 18 years of age may compete if all the following conditions are met:
 - 2.4.4.1. The minor drivers’ parent or legal guardian must be present at the event. Legal guardian must present a copy of his or her court ordered status as legal guardian.
 - 2.4.4.2. The minor drivers’ parent or legal guardian must sign a “waiver of liability” form on behalf of their child competing in the event (form available from ChampCar).
 - 2.4.4.3. The parent or legal guardian must be present at all times the minor is on track, including the driving surface and the “hot pit.”
 - 2.4.4.4. The Event Director may limit the number of minor drivers allowed to compete at any event.
- 2.4.5. Any individual 16-years of age or older may be a crew member in the “hot pit” area, but only if all the following conditions are met:
 - 2.4.5.1. The minor crew members’ parent or legal guardian must be present at the event. Legal guardian must present a copy of his or her court ordered status as legal guardian.
 - 2.4.5.2. The minor crew members’ parent or legal guardian must be present to sign a “waiver of liability” form on behalf of their child serving as a crew member (form available from ChampCar).
 - 2.4.5.3. The minor crew members’ parent or legal guardian must be present at all times the minor is on track, including the driving surface and the “hot pit.”

- 2.4.5.4. The Event Director may limit the number of minors allowed to crew at any event. The track may restrict “hot pit” areas to those over 18 at certain events; if so, the information will be in the Supplemental Rules for each event.

3. SAFETY SYSTEMS

3.1. ROLL-CAGES AND SUPPORTING STRUCTURE

3.1.1. A quality, well-fabricated, full roll-cage is required. Roll-cages may be weld-in or bolt-in. Roll-cage tubing joints may be welded or bolted, provided bolt-in methods meet conventional safety standards. Roll-cage design and construction must maintain typical SCCA/NASA standards.

3.2. ROLL CAGE DESIGN

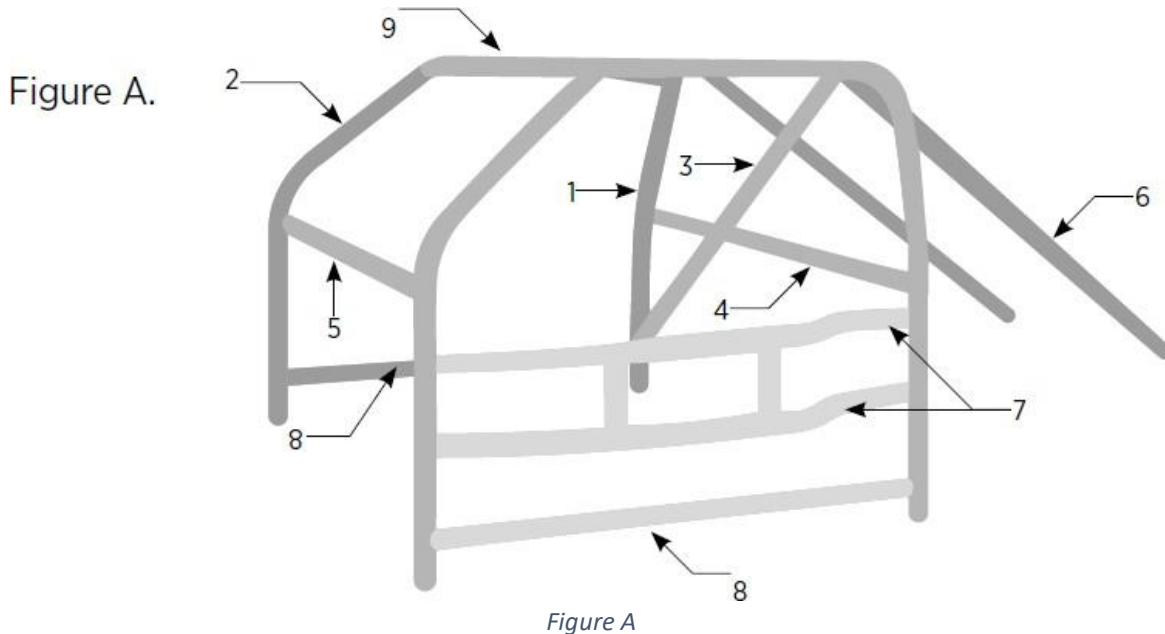

3.2.1. The main hoop (behind the driver, labeled “1” in Figure A) must be the full width of the cockpit for all cars. It must be one continuous length of tubing with smooth bends and no evidence of crimping or tube wall failure.

3.2.1.1. A 3/16” inspection hole must be drilled in the main hoop, such that a Tech Inspector has access to measure the wall thickness of the main hoop without obstruction.

3.2.1.2. On all closed cars, the main hoop must be as close as possible to the roof (in height) and “B” pillars (in width)

3.2.2. The halo hoop (labeled “9” in Figure A) may be constructed of either a U-shaped bar appropriately attached to the main hoop and two front vertical legs (labeled “2” in Figure A), OR front vertical bars bent rearwards at the roof line, connecting to the rear main hoop and cross-braced horizontally along the upper windscreen line.

- 3.2.3. Two driver-side door bars are required (labeled “7” in Figure A) that will prevent cockpit intrusion. NASCAR-style (Figure A) or Double-V style (Figure E) are recommended. NASCAR and Double-V designs must contain two continuous/unbroken bars. X-design containing 1 unbroken bar and one interrupted bar (Figure B) is acceptable with appropriate reinforcement.
- 3.2.3.1. X-design door bars in which one leg of the X is interrupted at the center of the X are permitted when appropriately gusseted and accompanied by a continuous/unbroken sill bar. (Figure B) ChampCar recommends using two unbroken bars if possible.

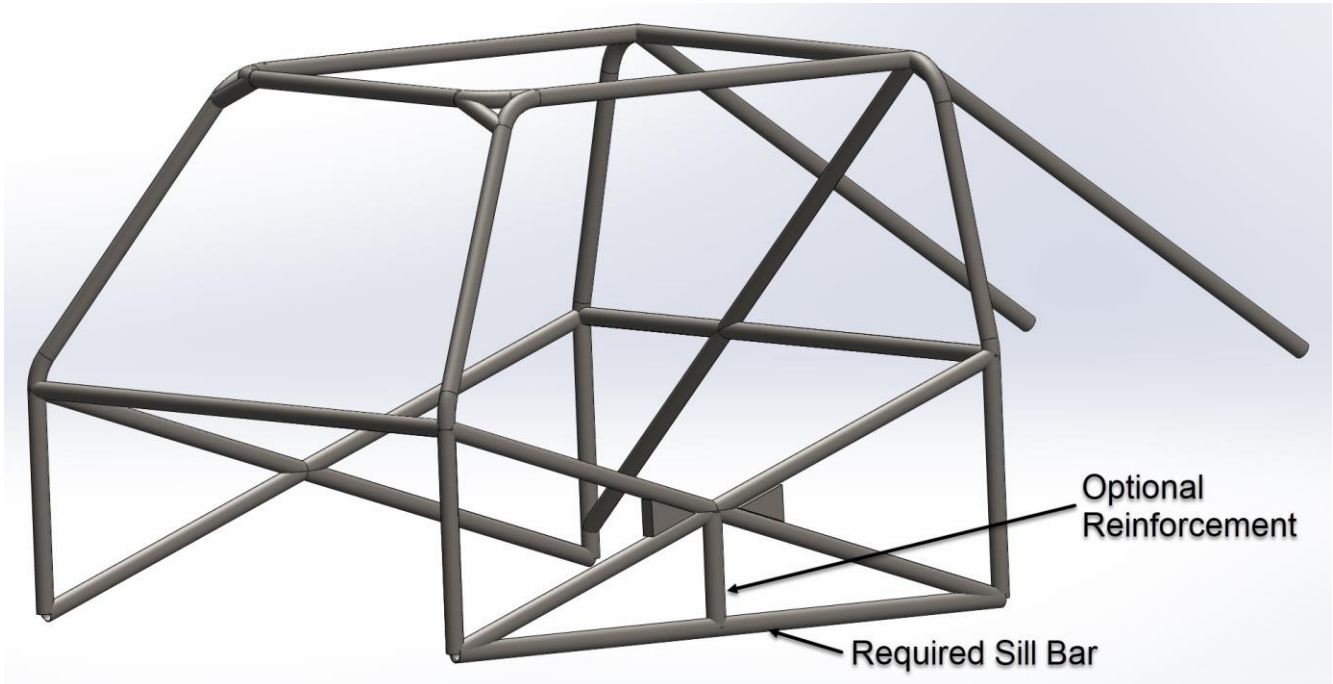

Figure B

- 3.2.3.2. A minimum separation distance of 4.5" is required between the uppermost and lowermost door bars at the junction to the A and B Pillars. Refer to Figure C.

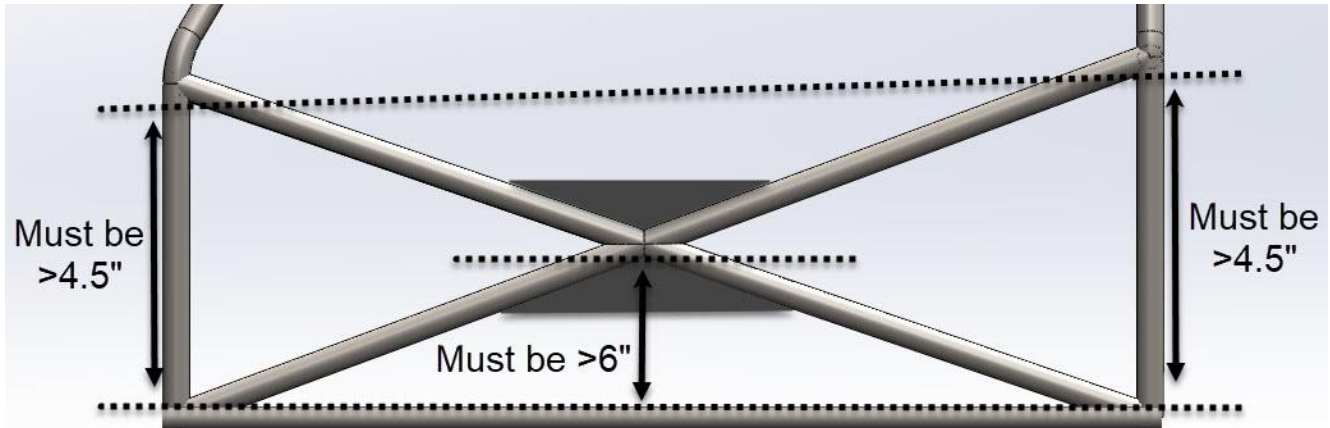

Figure C

- 3.2.3.3. The upper door bar shall not be placed higher than the bottom of the driver's window and at its lowest point must be at least 6" above the door sill. For X-design, the joint must be at least 6" above the door sill. Refer to Figure C.
- 3.2.3.4. If the distance, measured at any point between the highest portion of the door sill or floor pan (whichever is higher) and the lowest edge of lower door bar is greater than ten inches (10"), a floor or lower-sill intrusion bar (labeled "8"), mounted as low as possible on each side of the roll-cage, at or just above the door sill, joining the front vertical legs and the main hoop is required.
- 3.2.3.5. A minimum of one (1) door-bar shall be required on the passenger side. This bar can be a floor, or sill, or mid-level door-bar.
- 3.2.4. Appropriate main-hoop rear-supports (back-stays, labeled "6" in Figure A) with no bends, located as close to 45 degrees from horizontal as practical are required.
- 3.2.5. One main-hoop diagonal support bar (labeled "3" in Figure A) installed in the same plane as the main hoop, with one end terminating in general proximity to the main hoop bend above the driver's head and the other end terminating in general proximity to the lower end of the opposite side of main hoop is required. The diagonal support bar may be of one (1) or two (2) piece construction and it may intersect with or cross-through the horizontal support bar (used for seat belt harness attachment and/or seat support).
- 3.2.6. Complete 360-degree welds are required at all welded joints. All welds to be sufficient in heat, penetration, bead, and consistency.

Figure B. ChampCar defined “maximum, value-free” roll-cage

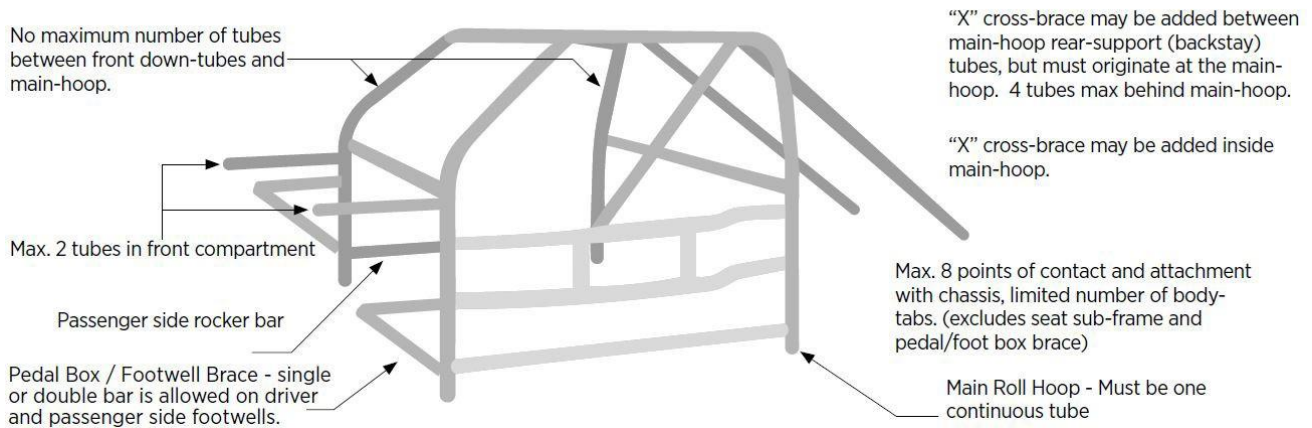

Figure D

- 3.2.7. Each major load-bearing member must be formed from its own single, continuous tube.
- 3.2.8. A shoulder-harness bar (labeled “4” in Figure A) mounted just below the driver’s shoulder level is required.
- 3.2.9. A dash bar (labeled “5” in Figure A) is mandatory. The dash bar must be of appropriate roll cage material per 3.2.12. The factory dashboard support bar does NOT meet this requirement. NOTE: Installation using minimal bends is strongly recommended.
- 3.2.10. Roll-cages are limited to eight (8) body and/or frame mounting points – welded and/or bolted.
 - 3.2.10.1. The total number of mounting points does NOT include a sub-frame to support a seat mount, provided that the seat sub-frame does not exceed two (2) chassis contact pads. There is no limit to the number of bars allowed for free between the main hoop to the front A-Pillar down bars.
 - 3.2.10.2. The total number of mounting points does NOT include welded tabs connecting any hoop to the body. A “tab” is defined as being not greater than 3/16” thick steel plate, no longer than six inches (6”), and a maximum of two (2) tabs may be placed within any 36” of tube.
 - 3.2.10.3. The total number of mounting points does NOT include pedal box/foot well bracing contact pads.
 - 3.2.10.4. Where cages are attached to the vehicle unibody, tubes must be welded to a minimum 1/8” steel plates no less than 16 square inches in size.

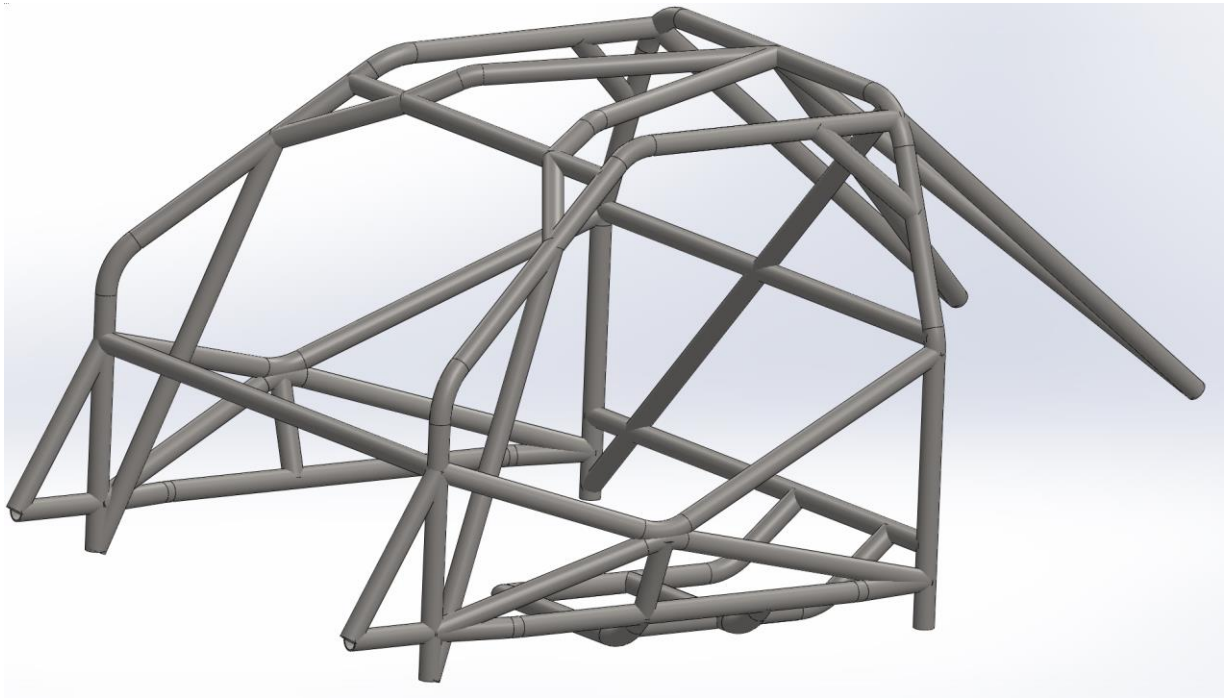

Figure E

3.2.11. Additional Bars:

- 3.2.11.1. Roll-cages may not have more than four (4) tubes installed behind the main hoop and two (2) of these must include the main hoop rear-support (back stay) bars without value add. There is no limit to the number of bars allowed for free between the main hoop to the front A-Pillar down bars.
- 3.2.11.2. Roll-cages MAY contain a maximum of four tubes (two per side) for pedal box / foot well bracing.
- 3.2.11.3. Roll-cages MAY contain a maximum of 2 tubes inside the front engine or storage compartment and each tube MUST terminate prior to the centerline of the front axle.

3.2.12. Roll-cage Steel Tubing and Hardware:

- 3.2.12.1. Minimum tubing size for cars weighing UNDER 2,500 pounds: 1.50" x .095".
- 3.2.12.2. Minimum tubing size for cars weighing OVER 2,500 pounds: 1.75" x .095" or 1.50" x .120".
- 3.2.12.3. For purposes of determining tubing sizes, the vehicle weight is as raced without fuel and driver.
- 3.2.12.4. Properly bent, quality tubing is mandatory. No stretched or crushed bends allowed. DOM mild steel is very strongly recommended over ERW tubing.
- 3.2.12.5. The radius of all bends of the roll cage (measured at centerline of tubing) must not be less than three times the diameter of the tubing.
- 3.2.12.6. All attachment points on the vehicle must be selected and reinforced as necessary so that, in an accident, the roll-cage will not punch through, tear, or grossly distort any roll-cage attachment point. Heavily rusted floor pans must be replaced or reinforced with sheet steel plate. Spreader plates, gussets, and/ or other reinforcing hardware are generally required to meet this goal. Minimum 1/8" (0.125") (3.175mm) thick steel

backing plates – not washers – must be present on the reverse or underside of any bolt-in cage location.

3.2.12.7. All mounting hardware is to be SAE Grade 8/Metric Class 10.9 or better.

3.2.12.7.1. Minimum bolt size is 3/8" or 10mm diameter.

3.2.12.7.2. All nuts should be self-locking (Nylok / ovalized) or cotter-pinned or drilled and safety-wired.

3.2.13. No waivers or "repair by next event" allowances will be granted on any roll-cage issue. Make sure it's 100% right the first time.

3.2.14. All roll-cages / seats / drivers must be fit such that when the driver is securely belted in-place, the top of the driver's helmet does not extend above the centerline of the main hoop. This applies to ALL drivers on the team. Any driver found in violation of this rule will be black flagged and the car withdrawn from competition until repairs or modifications have been made and the car completes a re-tech inspection.

3.2.15. All roll cage tubing must be padded with high density roll bar padding wherever a driver's extremity may contact the tube. SFI 45.1 Rated Roll Bar Padding is required wherever a helmet may contact the roll cage.

3.2.16. In order to prevent massively expensive roll-cages that start to look and act like a tube-frame chassis, ChampCar has defined the "maximum, value-free" roll-cage. The "maximum, value-free" roll-cage includes all pads, points, tubes and triangulations necessary to maintain an extremely high degree of safety, while keeping costs in check and competition well balanced. Teams MAY exceed the design and application of the "maximum, value-free" roll-cage; however, additional value will be assessed by the Tech Inspector, based on the perceived performance enhancement of the roll-cage.

3.3. DRIVER'S SEAT

3.3.1. The back of all driver's seats must extend in height to above the middle of driver's helmet or higher.

3.3.2. One or two-piece SFI or FIA-rated competition seats are recommended. OEM seats are NOT allowed.

3.3.3. All seats or seat-sliders must be securely mounted to the floor or roll cage to avoid separation during a crash. All mounting hardware must be SAE Grade 8/Metric Class 10.9 or better and a minimum 2-inch diameter or larger steel plate or load washers are required when mounting to sheet metal.

3.3.4. All seatbacks must be permanently fixed, braced or otherwise restrained against forward and/or rearward failure. A one-piece, permanently mounted seat meets this requirement.

3.3.5. All non-SFI or non-FIA rated seats must be within 3" of the shoulder harness bar or the diagonal main-hoop bar in its furthest forward position. For seats which do not meet this requirement, a seatback support MUST be used.

3.3.5.1. The seatback support may be permanently attached to the seat. For those supports not attached to the seat, the support MUST extend such that the support plate or contact point of the support mechanism is less than one half inch (0.5") from making contact with the seat when it is in the furthest forward position.

- 3.3.5.2. Seatback supports MUST maintain a minimum area of support contact of no less than sixteen square inches (4" x 4" square or 2" x 8" horizontal plate) and must be no less than 1/8" (0.125") in thickness.
- 3.3.5.3. All two-piece seats must have a permanently attached seatback support mechanism.
- 3.3.6. Seat Mounting - Teams are permitted to modify the OE sheet metal in the vicinity of the drivers position to permit safe mounting of the driver's seat. Seat mounting materials and sheet metal used for these modifications do not incur points. However, ChampCar reserves the right to assess additional points if the modifications exceed what is necessary to safely mount the driver seat and add perceived performance enhancement.

3.4. RACING HARNESES

- 3.4.1. All drivers in ChampCar sanctioned events shall utilize a five, six or seven-point restraint harness system. A five-point harness is considered a minimum restraint system. Six or seven-point systems are highly recommended. Harnesses may utilize 2" or 3" shoulder belts. PLEASE NOTE THAT NECK RESTRAINT SYSTEMS ARE AVAILABLE FOR 2" AND 3" BELTS, AND YOU MUST MATCH YOUR NECK RESTRAINT TO YOUR HARNESS.
- 3.4.2. All driver restraint systems shall meet SFI or FIA specifications. The certification indicated by an SFI label or FIA label must be present. SFI Harnesses must display an in-date conformance label. FIA harnesses expire on December 31st of the year of expiration sewn into harness. For harnesses with both FIA and SFI certification labels, the latest expiration may be used. Any attempt to modify the date(s) on any belt are grounds for immediate team disqualification, without recourse or refund. Harness threading tips: See Appendix 4 – Belt Install
- 3.4.3. All driver restraint systems shall be installed per applicable manufacturer recommendations. ChampCar recommends carefully following these instructions to avoid common installation errors, including but not limited to: Missing cotter pins on snap locks, incorrect Installation angles and distances, and incorrect shoulder harness wraps.

3.5. WINDOW NETS / ARM-RESTRAINTS

- 3.5.1. All competition cars must have an SFI-approved window net mounted to the cage of the car only. All window nets must be installed so that the front edge intersects the plane created by the steering wheel. (Figure F) When securely belted in place, the drivers' arm should not extend beyond the wrist out of any portion of the window. Cars with nets that have extensive openings, as defined solely by ChampCar officials, will NOT be allowed on track.

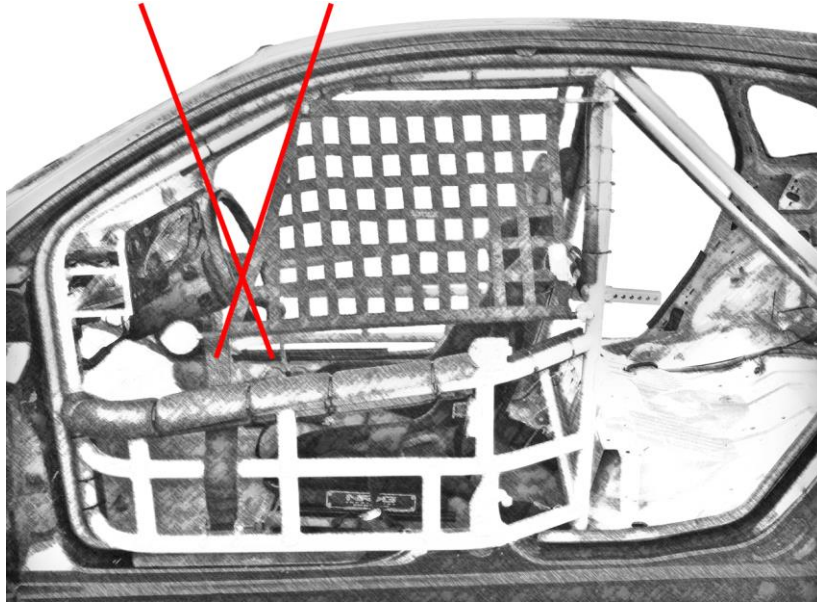

Figure F

- 3.5.1.1. All window nets shall meet SFI or FIA specifications. The certification indicated by an SFI label or FIA label must be present, including a clear "Date of Manufacture" label or, in the case of FIA labels, "Date of Expiration." SFI nets list a year of manufacture, and ChampCar will accept them until December 31st of the fourth year from the year of manufacture. FIA nets expire on December 31st of the year of expiration sewn into net. Any attempt to modify the date(s) on any net are grounds for immediate team disqualification, without recourse or refund.
- 3.5.1.2. A small piece of deformable, transparent polycarbonate may be used to screen in an exposed area of the driver's side window (left exposed by the window net) without value add PROVIDED the piece of screening plastic does not exceed eighty square inches and is a maximum 1/8" in thickness.
- 3.5.2. ROOF NETS or SFI-CERTIFIED ARM RESTRAINTS ARE REQUIRED in all open (convertible) cars and/or cars with t-tops or sunroof openings.
- 3.5.2.1. All arm restraints shall meet SFI or FIA specifications. The certification indicated by an SFI label or FIA label must be present, including a clear Date of Manufacture label or, in the case of FIA labels, Date of Expiration. SFI restraints list a year of manufacture, and ChampCar will accept them until December 31st four years from that year. FIA restraints expire on December 31st of the year of expiration sewn into item. Any attempt to modify the date(s) on any restraint or net are grounds for immediate team disqualification, without recourse or refund.

3.5.2.2. Driver Arm Restraint Confirmation and Testing:

- 3.5.2.2.1. At pit out, where all cars are required to stop, all drivers of open (convertible) cars and/or cars with t-tops or sunroof openings, without roof nets, shall be required to perform an arm restraint exhibition and test, by raising both arms to their maximum allowable height.
- 3.5.2.2.2. At full vertical extension, the driver's hands must NOT extend above a linear plane defined by the bottom edge of the lowest bar comprising the roll cage "halo."

3.5.2.3. Penalties

- 3.5.2.3.1. Drivers of open (convertible) cars and/ or cars with t-tops or sunroof openings who fail the extension test at pit out will NOT be allowed on course. Drivers will be directed to remove their car from the pit out lane to a location that does not impeded other cars and make the necessary adjustment to their arm restraints. Upon completion of adjustments, they must recomplete the test, at the availability of the pit out marshal.
- 3.5.2.3.2. Drivers of open (convertible) cars and/ or cars with t-tops or sunroof openings inspected at pit out who have not properly attached their arm restraints, roof nets, or are completely missing arm restraints will be issued a 5-minute penalty at pit out.
- 3.5.2.3.3. Drivers of open (convertible) cars and/or cars with t-tops or sunroof openings found at pit in without arm restraints or roof net, and having been on track, will be issued a 10-minute penalty at pit in.

3.6. DRIVER EGRESS

- 3.6.1. It is critical that all drivers and crew members are well practiced at releasing belts, cooling tubes, radio wires, and any other attachments quickly. All drivers must be able to quickly remove themselves under potentially life-threatening conditions. IT IS EXTREMELY IMPORTANT THAT EVERY TEAM MEMBER PRACTICE EMERGENCY EGRESS BEFORE EVERY EVENT!

3.7. STEERING WHEEL LOCKS

- 3.7.1. Steering wheel lock devices shall be removed or disabled. Quick-disconnect steering wheels are highly encouraged.

3.8. AIRBAGS

- 3.8.1. All airbags must be disarmed and removed.

3.9. ONBOARD FIRE EXTINGUISHER

- 3.9.1. ALL CHAMPCAR COMPETITION VEHICLES MUST HAVE A SELF-CONTAINED PUSH-BUTTON OR PULL-HANDLE FIRE SUPPRESSION SYSTEM INSTALLED.
 - 3.9.1.1. Fire suppression systems must have SFI or FIA certification.
 - 3.9.1.2. Minimum 5 LB or 2 Liter bottle capacity –ABF/AFFF/FE-36/NOVEC 1230 – Rechargeable systems are highly advised.
 - 3.9.1.3. Minimum two (2) extinguisher nozzles, one (1) pointed centrally towards the top and center of the engine, and one (1) located in the driver's seating area. THIS IS THE

MINIMUM. Be advised that multiple nozzles reduce line pressure and more quickly exhaust the fire suppression system. Competitors are advised to match the system capacity to the desired number of nozzles and area of coverage.

- 3.9.1.4. Onboard Fire Suppression Systems shall be inspected for recertification at least every two years after the date of original certification or as specified by the certifying manufacturer. When a unit is determined to be acceptable for continued service, a new conformance label marked with the inspection date shall be used. Infield recertification is permitted, but ONLY by the original manufacturer or its authorized agent. Mailing of certification labels to customers is strictly prohibited. Systems shall have a maximum field service life of 6 years (SFI) or 10 years (FIA) from the original date of installation.
- 3.9.2. All onboard fire systems shall identify the activation point for the automatic system by a circle "E" decal. Decals available at ChampCar Tech Inspection.
- 3.9.3. Cars arriving at pit in or pit out with the fire system arming pin not removed will be issued a 5-minute penalty.

3.10. DRIVER'S HELMET

- 3.10.1. An undamaged full-face helmet, displaying Snell Type SA2015 or SA2020 , or FIA certification is required.
Note: Snell Type M helmets (motorcycle) or other non-SA helmets are not rated for fire resistance and are not allowed.
- 3.10.2. All helmets expire 11 years after date of certification.
- 3.10.3. Helmets showing any sign of abuse or accident damage shall not be used during a ChampCar event.
- 3.10.4. Any driver with a helmet found with an altered or counterfeit Snell sticker shall be banned from that event.
- 3.10.5. Sharing helmets between team members is very highly discouraged.

3.11. NECK RESTRAINT SYSTEM

- 3.11.1. An undamaged FIA and/or SFI approved racing neck restraint system is mandatory.
- 3.11.2. SFI approved neck restraint systems must display a valid SFI conformance sticker. Devices must be recertified every 5 years per SFI 38.1
- 3.11.3. FIA approved neck restraint systems must display a valid FIA conformance sticker. FIA devices do not require recertification, however FIA guidance per Standard 8858-2010 must be followed.

3.12. FIRE RETARDANT CLOTHING

- 3.12.1. Condition
 - 3.12.1.1. Any clothing which is worn, frayed, torn, has holes, grease/oil stains or any other conditions that reduce or negate the item's designed effectiveness shall NOT be used during a ChampCar event..
- 3.12.2. Suit and Undergarments
 - 3.12.2.1. An FIA and/or SFI Certified racing suit is required.
 - 3.12.2.2. All drivers suits possessing a valid FIA and/or SFI certification shall be allowed, regardless of date of certification or manufacture.

3.12.2.3. If using a single-layer SFI 3.2/A1 or 3.2/A3 suit, the driver must also wear fire retardant SFI- or FIA- certified undergarments. Multilayer suits rated SFI 3.2/A5 or higher are highly recommended and may be worn without undergarments.

3.12.3. Gloves, Socks, and Shoes

3.12.3.1. Fire retardant FIA and/or SFI certified gloves, socks, and shoes are required.

3.12.3.2. All gloves, socks, and shoes possessing a valid FIA and/or SFI certification shall be allowed, regardless of date of certification or manufacture.

3.12.4. Balaclava

3.12.4.1. FIA and/or SFI rated Balaclavas are strongly encouraged but are not mandatory.

Balaclavas are required for drivers with beards, or drivers with long hair that is not fully covered by their helmet. Hair protruding from beneath a driver's helmet shall be completely covered by fire resistant material. As an alternative to balaclavas, a full SFI or FIA rated helmet skirt may be used.

3.13. ANNUAL GEAR CHECK

3.13.1. Gear inspection, use, and maintenance is each member's personal responsibility. Members are required to annually inspect all personal safety gear and confirm it meets ChampCar minimum requirements. By accepting a member's annual gear check, neither ChampCar, nor its directors, officers, sponsors, staff, and/or officials, ensure, certify, or warrant that the gear fully complies with all ChampCar rules, or will prevent bodily injury, death, or other harm (including, monetary damages). ChampCar expressly disclaims all consequential damages, regardless the cause.

3.14. BATTERIES

3.14.1. All batteries must be installed in a safe location. All batteries must be fully secured via proper, purpose built metal battery brackets, battery frames, or sealed battery boxes.

3.14.2. Positive ("hot") terminals must be in a sealed battery box or covered with insulating material.

3.14.3. All batteries located in the driver's compartment of the car shall be enclosed in a plastic, aluminum, or metal box.

3.14.4. Lithium-Ion (LiCoO₂) and Lithium-Polymer batteries are NOT allowed. LiFePO₄, gel, and lead acid batteries are allowed.

3.15. MASTER ELECTRICAL KILL (CUT-OFF) SWITCH

3.15.1. All cars must have a racing type master electrical kill switch securely mounted in a location accessible to and by the driver while he/she is secured in the driving seat by all seat belts and harnesses. The control or key for this switch should be red and the OFF position should be clearly indicated. Both the main battery circuit and the ignition circuit must be interrupted by the kill switch. All electrical cut-off switches shall be identified by the international lightning bolt symbol. Decals available at ChampCar Tech Inspection.

3.15.2. The dash or console switch MAY be the sole kill switch, or it MAY be a second switch, wired in series with an existing or additional switch located elsewhere on the car. If the switch is wired in series, the interruption of either switch, independent of the other, must kill all power and vehicle operations.

3.15.3. ALL terminals of the Kill Switch are to be treated as "hot" terminals and must be insulated.

3.15.4. At technical inspection, the kill switch function will be tested by revving the engine to approximately 1500 RPM and turning off the switch. The engine must shutoff immediately.

3.16. TOW HOOK

3.16.1. All cars must be equipped with a suitable front and rear tow hook (or chain or strap), constructed of materials and installed so that they are capable of withstanding the tension required to extract your car. Minimum 2" diameter opening and easily accessible. Tow point must be clearly marked on car. Rigid tow hooks that protrude beyond the bumper are not permitted.

3.17. DRIVE SHAFT

3.17.1. All cars that have modified the OEM driveshaft or swapped in a non-OEM driveshaft must use a driveshaft safety loop.

4. VEHICLE VALUE

4.1. TOTAL POINT VALUE

- 4.1.1. Cars with total points in excess of 500 points will receive penalty laps (1 lap per 10 points over allowable 500 point maximum). Points will be rounded up to the next multiple of '10'. Greater than 500 and less than 510 will be rounded to 510, greater than 510 and less than 520 will be rounded to 520 and so on.
- 4.1.2. Total Point Value of the race car is the combination of:
 - The Vehicle Performance Index
 - Non-Stock replacement or other added parts from the Fixed Point Value list
 - Non-Stock replacement or other added parts NOT on the Fixed Point Value list
 - Engine, transmission/transaxle, differential Swap Points

4.2. VEHICLE PERFORMANCE INDEX

- 4.2.1. The Vehicle Performance Index (VPI) is the assessed value (by ChampCar) of the Performance of the ChampCar competition vehicle. The VPI for most common ChampCar Endurance Series vehicles can be found at <https://champcar.org/web/register/vpi.php>
 - 4.2.1.1. All models must be standard factory offerings. Special, custom or limited editions are not included (Unless identified as such in the VPI).
 - 4.2.1.2. Factory supercharged or turbocharged vehicles must add 100 points to the listed value (Unless already identified as such in the VPI).
- 4.2.2. If a make/model/year of a vehicle that you have an interest in racing is NOT listed, contact ChampCar through the Tech Desk system <https://champcar.org/tech>. New vehicles may be raced upon approval through the Tech Desk. New vehicles may be temporarily placed in EC pending review of VPI value until an appropriate value is determined.
 - 4.2.2.1. Vehicles less than 15 years old will not be assigned VPI values.
 - 4.2.2.2. Vehicles more than 15 years old MAY be assigned a VPI value, at the discretion of the board of directors.
- 4.2.3. VPI's may be petitioned for review. A request for review is to be submitted to ChampCar through the Tech Desk system at <https://champcar.org/tech>
- 4.2.4. Vehicle additions to the VPI table will be added quarterly. Adjustments to existing VPI, SPV, and SVPI values will be posted once per year with the release of the new BCCR in the Fall. All changes will go into effect on January 1st of the following year.

4.3. FIXED POINTS

- 4.3.1. Non-stock Component Values: ChampCar has assigned a FIXED POINT VALUE that will be applied to MOST non-stock and/or performance components.

4.3.2. Fixed Point Value List:

- ABS, Non-OE, from a vehicle on VPI list: 25 pts
- Aerodynamic Devices (See Appendix 1 – Aerodynamic Anatomy for more info)
 - Spoiler / Wing / Splitter / Diffuser / Aero Pan / Air Dam / Side Skirts: 10 pts/ea
 - Any added aero component outside of the defined components will be charged points based on square feet of material
- Alternator, non-OE and not from VPI List: 10 pts
- Adjustable Cam Gear(s): 5 pts single, 10 pts multiple
- Automatic Transmission: Subtract 75 pts
To qualify for this deduction, the transmission must be equipped with a fluid coupling device (torque converter)
Dual clutch gearboxes are not considered automatic and do not qualify for the deduction
- Brake Caliper, 5-piston or more: 5 pts each
- Camber / caster adjustable plates / extended ball joints / other apparatus:
 - Aftermarket (pair): 20 pts front, 20 pts rear
 - Homemade (pair) 5 pts front, 5 pts rear
 - Stock components (strut towers, suspension arms, subframes) redrilled/slotted for adjustment: 0 pts
- Camshaft – Non-OE or reground or reprofiled OE camshaft, (Includes Springs, Lifters, Pushrods): 50 pts per engine
- Carburetor: 25 points
- Clutch, Multiple Disk system: 50 pts
- CV's / axles, non-OE (pair): 25 pts
- Cylinder head(s), non-OE and/or nonmatching to your specific engine claimed. 100 pts per engine
- Differential cover, non-OE: 5 pts
- Differential swap: 25pts for any diff not originally available for your year, make, and model or chassis generation (excluding specialty high performance models not listed on the VPI table). Includes axles and CV's
- Distributor, non-OE, or non-OE ignition system (includes coils): 20 pts
- Driveshaft, non-OE: 10 pts per single driveshaft
- Dry sump assembly: 100 pts
- Exhaust header: 25 pts per engine
- Fiberglass/Composite Hood: 25 pts per engine
- Heim joints: 5 pts each
- Hub, non-OE: 2.5 pts each
- Ignition coil(s), non-OE: 10 pts
- Intake Manifold: 25 points
- Mounts, non-OE, engine/transmission: 10pts per engine / 10 pts per transmission
- Offset bushings: 5 pts/corner
- Oil accumulator (e.g. – Accusump): 10 pts
- Oil cooler, non-OE (engine, transmission and/or differential): 20 pts each

- Oil pan, non-OE: 15 pts
- Pulleys, engine accessory, non-OE: 5 pts for one pulley, 10 pts for multiple pulleys
- Shock absorbers / struts with damping/rebound adjustment, includes remote reservoir, 25 pts per corner
- Shock / strut tower reinforcement bar (commercial or homemade): 10 pts each
- Suspension Springs, non-OE coil springs are 5-points per corner
 - Exemption: Vehicles may replace OE coil springs for 0-points provided that the replacement spring:
 - Is the same shape as the OE spring (straight, frustum, beehive/keg, etc.).
 - Maintains the exact same ID/OD measurements as the OE spring (+/- 0.25") when measured at the midpoint and at each end of the spring
 - Springs may be cut and/or used with spacers (spring rubbers) for no additional points
 - Shape and measurements must match when the springs are in their original unaltered condition
 - Torsion bars may be replaced with non OE torsion bars for 0-points if they are used in conjunction with OE mounting points and hardware
 - Additional leafs may be added to leaf spring packs for 0-points
- Adjustable spring perches, or any non-OE part or modification giving ride height adjustability 10-points per corner. Any metallic spring may be used in conjunction with the adjustable corner for no additional points
- Suspension component (not otherwise listed in this table), non-OE: 10 pts per corner per component
- Sway bar, non-OE, including end links: 20 pts each axle
- Sway bar end link, non-OE, including Heim Joint(s) – 5-points per corner
- Throttle Body: 25 points
- Transmission / Transaxle swap:
 - 25pts for any transmission / transaxle from a vehicle on the VPI list, includes adapters
- Tubular front subframe/K-member (bolt on only): 10 pts
- Turbochargers and superchargers, non-OE: 100 pts
 - Parts included with non-OE turbocharger/ supercharger installations are: exhaust/ intake manifold, pressure tubing, cooling lines, oil lines, and boost control systems
- Turbocharger and supercharger intercoolers, non-OE: 25 pts
- Valve train, non-OE: 50 pts per engine
- Valve Springs, non-OE: 10 pts per engine
- Water Pump, Electric: 10 pts
- Wheel spacers/hub adapters: 0 pts set of 4, max. 30mm/1.25" wide, max. 1/wheel
- Materials will be charged at the following rate:
 - Interior bulkheads: 0 pts
 - Plywood: 1 pt per sq.ft.
 - CARBON FIBER: NOT ALLOWED
 - Sheet aluminum/steel: 2 pts per sq.ft.
 - Sheet plastic/polycarbonate/fiberglass: 3 pts per sq.ft.

4.3.3. ChampCar reserves the right to apply an additional point value to any component or part that substantially increases the value and/or performance of the car.

4.4. NON FIXED POINT VALUE PARTS

- 4.4.1. ALL non-stock components, parts, assemblies, or systems MUST be declared to Tech Inspection and declared and accounted for in the total points of the vehicle.
- 4.4.2. There is NO SUCH THING as a free part, every part of a vehicle has a value. Parts not covered elsewhere in the rules will be assigned a point value by ChampCar Tech.
- 4.4.3. Any vehicle found with missing (ground off) or tampered part numbers on any part or component will be immediately reclassified as EC.
- 4.4.4. All point values assigned by Tech Inspection will be considered valid until ChampCar's Board of Directors assigns a fixed point value.
- 4.4.5. Carbon Fiber is not permitted anywhere outside of the driver's cockpit

4.5. ENGINE SWAP

- 4.5.1. Use the Swap Vehicle Performance Index Calculator at <https://champcar.org/web/register/vpi-swap.php> to determine your vehicle's total swapped value. The starting VPI of your vehicle when swapped may differ from the VPI of your un-swapped vehicle as listed in the VPI Index. This allows for substantially similar cars to be grouped together with the same starting value once the stock engine has been removed (I.E. All E30s start from 450 points)
- 4.5.2. The web page provides an automated calculator. The raw swap formula is:
 - IF $[16 - (SPV / (HP + hpAdd)) > 0]$
 - THEN $[0.032 * (16 - (SPV / (HP + hpAdd))) ^6] + 50$
 - ELSE + 50
- 4.5.2.1. "SPV" refers to the ChampCar Swap Performance Value of that make and model, as determined by ChampCar.
- 4.5.2.2. "HP" is the stock horsepower of the original engine.
- 4.5.2.3. "hpAdd" is the amount of extra horsepower being added to the car, not the HP of the new engine.
- 4.5.2.4. All of the above variables must be taken from ChampCar's database.
- 4.5.2.5. All engine swaps that result in a reduction of horsepower will be charged a flat 50 point fee.
- 4.5.3. Engine swaps include stock long block, OE stock exhaust manifolds, stock induction system, motor mounts, wiring, and transmission adapters.
 - 4.5.3.1. Any OE exhaust manifold from a vehicle on the VPI List can be used on a swapped engine for zero (0) points. Aftermarket headers will be 25-points on all vehicles regardless of fitment issues.
 - 4.5.3.2. The intake manifold used in the swap must be the OE or stock intake manifold that came from the engine you are swapping into your vehicle. If you need to swap to a different intake manifold from what engine is going into the car then it will be 25 points.
- 4.5.4. Maximum swap cost is \$2500 (engine & adapters).
- 4.5.5. Engine being swapped in must come from another vehicle in the VPI table, unless the Foreign Market Engine exception is used.
- 4.5.6. Foreign Market Engine Exception:
 - 4.5.6.1. Foreign market engines are permitted with no additional point value provided they have the same displacement and construction as the OE engine in the vehicle and are within 3% of the US/Canadian advertised horsepower.

- 4.5.6.2. Foreign market engines are permitted as substitutes for US/Canadian engines within the swap rule under the following conditions.
 - 4.5.6.2.1. Foreign market swap engine must be significantly similar to a US/Canadian engine from a vehicle on the VPI list (Same displacement and construction) and be within 3% of the US/Canadian advertised horsepower.
 - 4.5.6.2.2. Teams must use the US/Canadian advertised horsepower in the swap calculator.
- 4.5.6.3. Teams are required to present documentation of US/Canadian advertised horsepower and Foreign Market advertised horsepower to tech.
- 4.5.7. All other drive train components shall be stock. “Stock” is defined as the published specifications and technical measurements provided by the manufacturer.

4.6. PLATFORM SWAP

- 4.6.1. As an alternative to an engine swap, teams may qualify for a platform swap. A platform swap is defined as replacing the original components with all the components from the same chassis family (i.e. – 318 to 325 BMW engine swaps or 2.8L to 5.7L Chevy Camaro). To qualify as a platform swap, all of the differing vehicle components must be swapped to match the new platform. This includes engine, transmission, differential, suspension, fuel tank, etc. The VPI of the car will now be based on the car and engine combination as presented to tech, regardless of what engine may have been installed originally. No swap surcharges shall be applied to platform swaps.

4.7. OTHER EQUIPMENT THAT DOES NOT COUNT TOWARD THE TOTAL POINT VALUE

- 4.7.1. Teams may replace any worn, broken, ventilated, impaled, defective, or bent beyond all recognition parts on their car without affecting their total points so long as it’s an OE or OE equivalent part for that car’s specific model.
 - 4.7.1.1. Teams may repair/replace rusted/fatigued/ damaged portions of the chassis with similar thickness metal or OE approved repair components/methods. Repairs must maintain some likeness to the original body lines of the chassis.
 - 4.7.1.2. Teams may remove parts or portions of parts from their car without incurring points.
 - 4.7.1.3. STOCK engine rebuilds are permitted. “Stock” is defined as the published specifications and technical measurements provided by the manufacturer. Manufacturer overbore rebuilds are permitted.

4.7.2. Items that are point free:

- Air intake components ahead of throttle body (including air filter, air filter housing, air intake tubing, AFM/MAF)
- Air vents to driver
- All fuel system components (Excludes the fuel tank/fuel cell)
- Alternator (Must come from vehicle on VPI List)
- All brake system components, excluding ABS units and brake calipers over 4 pistons per 4.3.2.
- Clutch, stock type single disc. Excludes smaller diameter or multi-disc clutches, see 4.3.2.
- Cooling system hoses and vacuum lines
- Coolant Expansion Tanks
- Computers, ECU = Engine - TCU = Transmission – Includes Sensors
 - ECU, non-OE or chip replacement or chip re-programming
 - TCU, non-OE or chip replacement or chip re-programming
- Driver comfort & information items are open and do not count towards total points (i.e. - steering wheel, removable steering wheel adapter, shifter handles, gauges, pedals, cool suits, vents, heaters, radio communications, etc.)
- Engine accessory brackets
- Exhaust systems downstream of the header/ exhaust manifold (from the collector back)
- Final drive ratio is open to all factory offered ratios for that body style or chassis generation. If that body style or chassis generation was offered from the factory with an LSD, its use is permitted. Specialty high performance models not listed on the VPI table are excluded
- Flywheel
- Fuel Injectors / Carburetor Jets
- Hood Vents
- Hardware, fasteners, and materials used to attach things to other things (nuts, bolts, screws, rivets, duct tape, bailing wire, zip ties, JB Weld, etc.)
- Idler Pulley – Pulleys that only facilitate belt routing and do not drive any rotating pumps, gears, shafts will be permitted no points.
- Materials from your vehicle are permitted to be repurposed into other items for zero points, provided teams retain documented evidence of the process
- Non-adjustable Shock Absorbers
- Oil Pan Baffle
- Pedal Assembly Sets
- PCV (Crankcase Ventilation) system and hoses
- Power Steering Components
- Radiator
- Radiator Cooling Fan – OE fan may be replaced with aftermarket
- Remote Oil Filter & Lines
- Shifters, provided the original function is maintained (Conversion to paddle shift or sequential shift is not permitted)

- Starters
- Shocks/Struts, non-adjustable for rebound/ dampening, no remote reservoirs
- Suspension bushings, OE replacement or polyurethane/Delrin with OE geometry (OE hole location/offset, height, thickness)
- Screens protecting radiator and brake duct openings from debris
- Valve Covers, non-OE
- Water Pump, Mechanical

4.7.3. Drive by Wire Throttle Bodies:

- 4.7.3.1. Engines originally equipped with a drive by wire throttle body may replace the OE throttle body with a cable operated throttle body from any vehicle on the VPI list, as long as the replacement throttle body has an equal or smaller flow diameter.

4.8. TIRE SPECIFICATIONS FOR ALL CLASSES

4.8.1. Tires: Tire must be DOT legal and the UTQG treadwear rated at 180 or higher.

- 4.8.1.1. While tire size is open, tires may not extend beyond the cover of the fenders from the 10 to 2 o'clock positions. Fenders can be stretched/rolled to cover wider tires and flares can even be made, however any added materials used to enlarge the fenders will be charged at the material rate in 4.3.2.

5. SAFETY & TECHNICAL INSPECTIONS AND RELATED PENALTIES

5.1. INSPECTION PROCESS

- 5.1.1. All competitors must present their vehicle(s) to ChampCar International Inc., dba ChampCar Endurance Series (collectively, “ChampCar”), for annual safety and technical inspections.
- 5.1.2. By inspecting a vehicle, neither ChampCar, nor its directors, officers, sponsors, staff, and/or officials, ensure, certify, or warrant that
 - the inspection will detect any or every problem with the vehicle;
 - the vehicle or any part of the vehicle is safe; or
 - the vehicle complies fully with all ChampCar rules.
- 5.1.3. The inspection does not in any way change the fact that the driver, crew members, and vehicle owner are ultimately responsible for the safety, operation, and proper maintenance of the vehicle and personal safety equipment. ChampCar expressly disclaims all consequential damages, regardless the cause.

5.2. TECHNICAL INSPECTION

- 5.2.1. ChampCar Digital Tech inspection forms should be completed using the ChampCar website prior to entering the tech line.
- 5.2.2. Technical Inspections shall be done annually and, upon approval, a car will be issued a ChampCar Annual Inspection decal for that calendar year.
 - 5.2.2.1. Cars with a valid ChampCar Annual Inspection decal need NOT return for inspection UNLESS ANY OF THE FOLLOWING HAVE OCCURRED:
 - 5.2.2.1.1. The inspection decal has expired.
 - 5.2.2.1.2. The vehicle has undergone ANY major component exchange, swap or replacement, as a byproduct of an upgrade, repair and/or modification.
 - 5.2.2.1.3. The vehicle has realized the upgrade, exchange, replacement and/or modification of any safety item, including but not limited to kill switch, seat belts or harness, seat and/or installation, roll-cage or attachment mounts, fire extinguisher system, window or roof nets, fuel cell, etc.
 - 5.2.2.1.4. The vehicle has been involved in ANY major contact or shunt. NOTE: Following any such incident the vehicle’s Annual Inspection decal shall be removed by the Technical Inspector.
- 5.2.3. Appeals: The Technical Inspector’s ruling may be appealed to the Event Director. The Event Director’s ruling is final for that event. You may appeal for future races to the ChampCar Board of Directors at Board@champcar.org.

5.3. PENALTIES

- 5.3.1. Cars with total points in excess of 500 pts will receive penalty laps (1 lap per 10 points over allowable 500 point maximum. Points will be rounded up to the next multiple of ‘10’. Greater than 500 and less than 510 will be rounded to 510, greater than 510 and less than 520 will be rounded to 520 and so on.
- 5.3.2. Penalty Lap Assessment Adjustments for Length of Endurance Racing Events:

- 5.3.2.1. All penalty laps issued by Tech and/or as stated within the BCCR are applicable to 7-hour endurance racing events. Therefore, endurance event penalties shall be adjusted for longer endurance events:
 - 5.3.2.1.1. For races 8 hours or less, all penalties shall have a multiplier of 1.0.
 - 5.3.2.1.2. For races 9 to 16 hours, all penalties shall have a multiplier of 1.5.
 - 5.3.2.1.3. For races 17+ hours, all penalties shall have a multiplier of 2.0.
- 5.3.2.2. ChampCar's Event Directors shall have the ability to amend the multiplier to whatever factor is numerically related and/ or appropriate to the length of the track or event. If the Event Director chooses to amend the multiplier, the multiplier shall be specified in the Supplemental Rules of the event.

5.4. POST-RACE IMPOUND AND INSPECTION

- 5.4.1. At the conclusion of every ChampCar Race, the top five (5) finishing vehicles, overall, and class winners, shall be impounded for a period not less than 30 minutes and not more than 90 minutes.
- 5.4.2. During the impound period, the top five (5) finishing vehicles and class winners impounded must:
 - 5.4.2.1. Raise and place the car on four (4) jack stands, a minimum of 12" from the ground or floor level.
 - 5.4.2.2. Remove all four (4) wheels and tires.
 - 5.4.2.3. Open the hood and trunk.
- 5.4.3. ChampCar will make the cars Tech Sheet available for review.
- 5.4.4. ChampCar competitors and teams are welcome to "review" impounded vehicles. "REVIEW" does NOT mean touch or crawl under a competitor's car however, you may request a ChampCar official to look at an item for you.
- 5.4.5. During the impound period, the Event Director or Tech Chief may engage in any inspection they so choose, including but not limited to the partial or full disassembly of any assembly, system or component for legality.
- 5.4.6. Upon the close of impound, all race results are final.
- 5.4.7. Cars that have been found, whether during the event or in post-race impound, to be in violation of the rules will lose their annual tech sticker and be required to go through a new tech inspection process at each event the rest of the year.

5.5. PROTESTS

- 5.5.1. Any Team Captain has the ability to file a written protest with the Event Director or Tech Chief regarding any car in the event. Protests MUST be submitted to the event's Event Director or Tech inspector after the start of the race and prior to the close of post-race Impound. Protest forms are available in the "Rules" section of the ChampCar website.
 - 5.5.1.1. Driving Protest: Must include a written statement of the incident and be supported by video OR two additional driver statements OR the report of the Corner Marshal.
 - 5.5.1.1.1. Aggressive or unsafe driving protests that are accompanied by video or film documentation which do NOT offer clear and concise view(s) of the incident or infraction, or suggest any reasonable doubt, will be defined as a "racing incident."

- 5.5.1.1.2. No protest will be accepted for missed or non-calls by corner workers or track/event officials such as passing under yellow.
 - 5.5.1.2. Vehicle Protest: The protest must identify a maximum of five (5) items that may or may not be present on the protested car and are not claimed on the tech sheet.
 - 5.5.2. All protests must include a filing fee. A protest will result in:
 - 5.5.2.1. VALID PROTEST: A penalty is applied to the protested team and the protest fee is returned to protester.
 - 5.5.2.2. Valid driving protests penalties MAY result in penalty laps, a time penalty, or disqualification of the car, at the discretion of the Event Director.
 - 5.5.2.3. Valid vehicle protests will result in disqualification of the car, or reclassifying the car to EC, or adjusting the Total Vehicle Performance Index (TVPI), at the discretion of the Event Director.
 - 5.5.2.4. INVALID PROTEST: No penalty is applied to protested team and the protest fee is lost.
 - 5.5.3. During a 2-day race event, in order to allow a team to compete the following day without having to rebuild any assembly torn-down for post-race inspection, protested cars may have various assemblies or components marked and sealed for a delayed tear-down inspection after the final race of the weekend. Any penalty applied due to illegalities found during a delayed inspection will be applied to ALL race events of the weekend.
- ### 5.6. DAY TWO HANDICAP
- 5.6.1. For two-day endurance events (that is two separate races), the winning car on day one will receive a lap penalty on day two equal to the number of laps they won by on day one plus one extra lap. No victory penalties will follow a team once the weekend of racing is over.

6. ENTRIES AND TEAMS

6.1. ENTRY APPLICATIONS & PAYMENT DEADLINES

- 6.1.1. Each entry shall require a refundable \$250 deposit.
- 6.1.2. ChampCar will refund any fees paid upon request prior to the close of the event payment deadline (60 days). Inside of 60 days, fees will only be transferred to another event.
- 6.1.3. Early pay discount: The ChampCar auto-pay website will reduce the event fee by \$200 for any full entry payment made 60 days prior to the event.

6.2. ENTRY & DRIVER FEES

- 6.2.1. For all ChampCar Endurance Race Events entry fees will be set based on current track and support costs. See <https://champcar.org> for specific event pricing.
- 6.2.2. Every entry includes all drivers and crew. Some tracks may charge entry fees outside of ChampCar's fees. See the supplemental rules for that event.
- 6.2.3. AMB 260X, AMB/MyLaps X2, or a MyLaps TR2 transponder is required to compete. You can bring your own or rent one from ChampCar.
 - 6.2.3.1. Rental transponders must have a factory MyLaps/AMB transponder mounting bracket affixed to their car in an approved location (see BCCR Appendix). Mounts are sold by ChampCar at tech inspection. No loose or zip-tied or duct-taped transponders are allowed.
 - 6.2.3.2. If a rental transponder is lost or broken, you agree to be charged for its replacement. If the case is cracked or deformed in any way but the unit still works, you agree to be charged for repair and testing.
- 6.2.4. A Flagtronics FT200 is required to compete. You can bring your own or rent one from ChampCar.
 - 6.2.4.1. If a Flagtronics FT200 is lost or broken, you agree to be charged for its replacement.
 - 6.2.4.2. ChampCar strongly recommends installation of the flagtronics as described in Appendix 9 – Flagtronics. This will facilitate use of the FT200 as a pit-timer.

6.3. CATASTROPHIC FAILURE DISCOUNT

- 6.3.1. If a ChampCar or EC competitor's car experiences a catastrophic, non-repairable, mechanical failure (not the result of brain fade or collision while on the track) within the first two hours of the first day of any multi-day ChampCar Race event, ChampCar will extend a \$300 discount to that team for their next ChampCar entry.
- 6.3.2. If a team's car experiences a failure during a ChampCar event that prevents the vehicle from attending another event the team has entered later in the season, ChampCar will transfer their entry fee or deposit for that later event to any even later event at the discretion of the Event Director.

6.4. MINIMUM DRIVER ENTRIES PER CAR

- 6.4.1. Endurance Races:
 - 8-Hours or less - Two (2) drivers minimum
 - 9-16-Hours - Three (3) drivers minimum
 - 17-hours and above - Four (4) drivers minimum

7. RULES OF THE ROAD

7.1. MAXIMUM DRIVING TIME

- 7.1.1. Within an Endurance Race, no driver shall drive for more than 2 hours consecutively and shall have, at a minimum, sixty (60) minutes rest between stints.
- 7.1.2. Driver stint time starts at Official Race Start (green flag) time for 1st driver, or when driver is released from pit lane after a driver change.

7.2. ON-TRACK DRIVER CONDUCT

- 7.2.1. It is the responsibility of all drivers to avoid physical contact between cars on the race track. All competitors have a right to “racing room” on the marked racing surface. “Racing room” shall be generally defined as sufficient space on the marked racing surface to allow a competitor to maintain control of his/her car. CAR TO CAR CONTACT WILL RESULT IN A BLACK FLAG BEING ISSUED AND A TIME PENALTY TO BE SERVED.
- 7.2.2. The responsibility for passing another car and accomplishing that pass safely, rests with the overtaking driver. The driver that is about to be overtaken has the responsibility to be aware that he or she is about to be passed, give hand signals and shall not impede the overtaking car.
 - 7.2.2.1. The driver being overtaken should, at all times, remain on their racing line unless the car is impaired and is unable to maintain an adequate racing speed.
 - 7.2.2.2. The driver being overtaken shall not block. Any driver who fails to make use of their rear view mirror, or who appears to be blocking another car seeking a pass, will be black flagged and/or penalized.
 - 7.2.2.3. It is the responsibility of the overtaking car to prepare for, plan and execute a FULL and COMPLETE safe pass. The definition of a full and complete pass is when the overtaking car has extended a lead of approximately one car length ahead of the vehicle being passed.

7.3. STOPPING ON COURSE

- 7.3.1. If a driver is forced to stop his or her car on the course, he or she shall make every effort to place the car in such position that it will not be a danger or obstruction to other competitors, course workers or themselves.
- 7.3.2. Drivers stopping on course shall stay in their car with their seat belts firmly engaged and helmet in place until they are instructed by a corner worker or other race official to leave their car, UNLESS THE CAR IS ON FIRE.

7.4. PIT IN: UNSAFE DRIVER CONDITION

- 7.4.1. Drivers arriving at pit in, having been on track, found with their window net down or seat belt unbuckled, will be issued a 10- minute penalty at pit in.

7.5. PASSENGERS

- 7.5.1. Passengers are not permitted during a ChampCar race.
- 7.5.2. Passengers may be allowed during a ChampCar test session at the discretion of the event director.

8. RULES OF THE PIT

8.1. PIT AND/OR PADDOCK AREA

- 8.1.1. Unless otherwise noted in the Supplemental Rules, all fueling must be done on pit road.
- 8.1.2. While in the pits, each team entered in the event is REQUIRED to have ready a minimum of one (1) each:
 - 8.1.2.1. Ten (10) pound dry chemical or 3kg NOVEC fire extinguisher having a minimum UL 60 BC or ABC rating.
 - 8.1.2.2. Ten (10) pound bag of grease sweep, kitty litter or other absorbent for oil leaks and/or fuel spillage in their fuel storage area. (Having a broom is a good idea, too!)
 - 8.1.2.3. A suitable gasoline and/or liquid catch pan must be used during refueling in an appropriate position to catch any spilled fuel. All fueling / gasoline catch pans MUST be manufactured of metal or sturdy, chemical resistant plastic, maintain a minimum 3" depth, hold a minimum of 1-gallon (4-quarts) of liquid. Catch pans should be larger than 12" square or 12" in diameter. Oil drain pans work perfectly for this.
- 8.1.3. Unattended fuel or oil spills are punishable at the discretion of the Event Director.
- 8.1.4. All compressed air bottles/gas cylinders, with a pressure in excess of 200 psi, shall have a protective structure around their gauges and valves when in the pit/grid/pre-grid areas.
- 8.1.5. Unless restricted by the track, motorized paddock support vehicles are allowed PROVIDED that all drivers are 16 years or older and have a state issued driver's license. Unsafe driving in the pits/paddock may result in a penalty or even disqualification of the associated team at the discretion of the Event Director.
- 8.1.6. All used or junk parts too big for a normal trash can, empty fuel drums and anything else you brought with you must be taken out by you.

8.2. PIT STOPS AND FUELING OF VEHICLES

- 8.2.1. NO FUEL JUGS OR CREW MEMBERS ARE ALLOWED ON OR OVER THE WALL UNTIL THE CAR HAS COME TO A FULL AND COMPLETE STOP.
- 8.2.2. The fueling process starts when the gas cap is removed or whenever any fuel jugs are over the pit wall and ends when the gas cap is replaced and all fuel cans, catch cans, and drip pans are back over the pit wall. During this time, NO OTHER WORK IS ALLOWED ON THE CAR.
 - 8.2.2.1. Fire bottle operator must be in place before gas cap is removed.
- 8.2.3. During the fueling process any team member over the wall must wear a driver's suit possessing a valid FIA and/or SFI certification. It may be a single layer SFI 3.2/A1 or 3.2/A3, or multi-layer SFI 3.2/A5 or higher suit. A fireproof underwear layer is advisable but not required with single layer suits. HOWEVER, any suit determined by ChampCar to be worn, frayed, torn, have holes, grease/oil stains or other conditions that reduce or negate the item's designed effectiveness shall NOT be used during a ChampCar event. ChampCar's decision is final. Fire retardant FIA or SFI 3.3-rated socks and gloves are also required. FIA or SFI 3.3-rated Balaclavas are strongly encouraged but are not mandatory. Balaclavas are required for over the wall crew with beards, or drivers with long hair that is not fully covered by their helmet. Hair protruding from beneath an over the wall crew helmet shall be completely covered by fire resistant material. As an alternative to balaclavas, a full FIA or SFI-rated helmet skirt may be used. Standard closed toe "street" shoes can be worn by over the wall crew. Leather boots are

recommended. Non-driving over the wall crew members may wear an out-of-date Snell SA closed face with face shield helmet for pit duties. Crew members with out-of-date helmets shall mark both sides of their helmet with the words "FUEL ONLY" in 1.5", high-contrast and easily identifiable letters.

ALL FACE SHIELDS MUST BE DOWN DURING THE FUELING PROCESS

Optional: The fueler is allowed to wear an SFI 52.1 fueler apron in addition to the above over the wall fueling gear.

- 8.2.4. Each pit stop for fuel shall be a timed pit stop. The minimum time required per stop is five (5) minutes (pit in to pit out). Pit stops where fuel is not added to the car shall not be considered a timed pit stop.
 - 8.2.5. There is no minimum or maximum number of pit stops.
 - 8.2.6. All refueling jugs shall be DOT and/or ChampCar approved, with a maximum indicated capacity of five (5) gallons. "Dry Break" systems are allowed. Funnels are not allowed to be used for the fueling process. All fueling must be done through a hose or dry break nozzle attached to the 5-gallon fuel jug. Overhead, or elevated refueling rigs, or electro-mechanical units to assist in lifting or supporting a fuel container are NOT allowed. All fuel jugs are to be manually supported. Only one fuel jug allowed over the wall at a time.
 - 8.2.7. During the fueling process all cars MUST have their electrical kill switch in the OFF position.
 - 8.2.8. A MAXIMUM OF FIVE (5) PEOPLE ARE ALLOWED OVER THE WALL DURING FUELING.
 - 8.2.8.1. The driver exiting the race car MAY assist the driver entering the car, or MAY take one of the fueling positions. If the exiting driver goes over the wall, another appropriately dressed crew member may take his or her place.
 - 8.2.8.2. The driver entering the race car may ONLY be assisted with belts, radio connections, cool suit connections, and the window net during the fueling process.
 - 8.2.8.3. The crew member manning the fire bottle must manage an approved 10LB ABC fire extinguisher and be stationed no less than 8' and no more than 15' from the point where fuel is being added to the vehicle. This team member is restricted from performing any other duty or function while managing the fire extinguisher; their entire focus is to be a safeguard in case of a fire. THE FIRE BOTTLE SAFETY CREW MEMBER IS NOT ALLOWED TO HANDLE FUEL JUGS.
 - 8.2.8.4. The crew member fueling the car may only fuel the car while the fuel cap is removed. All fuel jugs are to be manually supported. Only ONE (1) fuel jug is allowed over the wall at a time and only ONE (1) fuel jug is to be poured into a car at a time.
 - 8.2.8.5. The crew member assisting the fueling process may position the fuel catch pan and/or overflow vent catch can, etc. may assist the with the driver change.
 - 8.2.9. TEAMS ARE RESTRICTED FROM STORING MORE THAN 25 GALLONS OF FUEL IN THEIR PIT STALL.
 - 8.2.10. THE USE OF ELECTRIC PUMP(S) TO REFILL YOUR FUEL JUGS IS NOT ALLOWED. All pumps used to transfer any fuel shall be mechanical pumps.
- 8.3. PIT STOPS AND TIRE CHANGES**
- 8.3.1. NO TOOLS, EQUIPMENT, OR CREW MEMBERS ARE ALLOWED ON OR OVER THE WALL UNTIL THE CAR HAS COME TO A FULL AND COMPLETE STOP.

- 8.3.2. The tire change process is in effect any time a team replaces a tire in the “Hot Pit” during a Champcar sanctioned event.
- 8.3.3. During a tire change process, only battery and/or hand tools are permitted over the pit wall. No Pneumatic tools are permitted.
- 8.3.4. During a tire change process, only 1 Lug tool (Battery or Hand), 1 Jack, 1 Torque Wrench, and Jack Stand(s) are allowed over the wall.
- 8.3.5. Tire change process tool restrictions are only applicable to tire changes. These restrictions do not apply for any repairs, adjustments, or changes required to any other vehicle components, which may occur concurrently to tire replacement activities.

9. MECHANICAL & ELECTRICAL SYSTEMS, ASSEMBLIES, COMPONENTS

9.1. GLASS – GENERAL

- 9.1.1. Rear and Side glass may remain in the car provided it is covered by a clear safety window film (not tape, not tint). Example: 3M Scotchshield

9.2. WINDSHIELDS

- 9.2.1. Cracked windshields will be carefully scrutinized. Cracks that are deemed a visual hazard to the driver or have the potential of losing their structural integrity upon impact by any object shall not pass Safety & Tech inspection, requiring removal prior to competition.
- 9.2.2. OE windshields may be removed. Stock replacement windshields or polycarbonate (Lexan) windshields of the stock dimensions are acceptable in the stock location. Plexiglas plastic is not acceptable. If your OE safety glass or a stock dimension polycarbonate windshield is not installed, you must have a complete hood with no holes or vents in place as your firewall.
 - 9.2.2.1. All polycarbonate windscreens and/or windshields MUST have a nominal thickness of at least 3/16".
 - 9.2.2.2. All cars with polycarbonate front windshields or windscreens are required to have front safety straps installed on the INSIDE of the cockpit to support the windshield and keep it from collapsing into the interior of the vehicle.
 - 9.2.2.2.1. A minimum of two (2) straps are required.
 - 9.2.2.2.2. Straps shall be 1 inch wide x 1/8 inch thick (aluminum or steel), and shall be bolted or riveted to the chassis or roll-cage at the top and bottom of the strap.
 - 9.2.2.2.3. The straps cannot be any further than 1" from contact with the front windshield.
 - 9.2.2.2.4. Placement of both straps should be approximately 12" apart and at least one strap may not be more than 12" from the centerline of the windshield.

9.3. SIDE & REAR WINDOWS

- 9.3.1. No covering of any type is allowed in place of the passenger's side window.
- 9.3.2. ONLY clear, transparent polycarbonate is allowed in place of any rear side or hatch window opening without additional value-add, provided:
 - 9.3.2.1. A factory-installed (OE) window was standard equipment for the year, make and model of car presented to Tech.
 - 9.3.2.2. The window opening is located behind the driver's seat or B-pillar (whichever is appropriate).
 - 9.3.2.3. All material must maintain a nominal thickness of at least 1/8".
 - 9.3.2.4. All windows must be attached by screw, rivet or bolt on a maximum 10" centerline around the perimeter of the window covering.
 - 9.3.2.5. The window covering must be the same size as the OE window.
- 9.3.3. All polycarbonate rear windows or hatches are required to have at least two (2) 1" x 1/8" aluminum safety straps installed on the OUTSIDE of the window/hatch to support the window and keep it from separating from the vehicle. Straps must extend the full length of the window/hatch and must be securely attached to the chassis or roll cage.

- 9.3.4. Rear and mid-engine vehicles where the rear window is an extension of the firewall may retain the OE-glass (MUST be covered by safety film) or add a replacement plastic panel with straps.

9.4. NERF BARS OR EXO-SKELETON

- 9.4.1. Added structural elements that extend beyond the outline of the original body line are not allowed. This includes additional structures holding lights or other components.
- 9.4.2. Roll-cage main hoops and halo bars may extend above the roof.

9.5. BODY PANELS

- 9.5.1. Hub caps shall be removed. All operable components of the vehicle's body (e.g. – hood, doors, hatch or trunk lid) shall have a latching mechanism or be securely fastened.
- 9.5.2. Each car entered must have a minimum of SEVENTY-FIVE PERCENT (75%) of the total body work and panels on the car. Vehicles must meet the "50/50" rule. This means vehicle must appear generally complete and be identifiable as similar to a stock version of the vehicle at 50MPH from 50 feet away. (See Appendix 2 – Chassis Modification Guide for more info).
- 9.5.3. Doors cannot be removed. All cars must have a door or "OEM equivalent" body panel. Doors do NOT need to open or be operative. Doors may be welded closed. Doors may be re-skinned, however, re-skinned panels must be covered with the same type, thickness and quality of material as originally presented by the manufacturer (no aluminum panels replacing steel panels). Doors shall, in general, match the shape and contour of the originally designed bodywork, including at least 75% of the original height, as measured upwards from base of the door line.
- 9.5.4. Body panels significantly supported or held solely in place by fabricated tubular, sheet metal and/or other forms of fabricated framework or brackets shall be charged for the materials associated with this structure. Body panels must maintain their original placement, shape and profile without the aid of other supporting brackets, rods, tubes or frames.
- 9.5.5. All cars without stock dimension windshields must have a hood. In this case, the hood is considered a firewall and must be complete with no holes or vents.
- 9.5.6. OE front and rear crash structures need to remain stock. Teams are not allowed to shorten, remove, or modify frame rails or significant portions of unibody structures outside of the wheelbase. This also includes cars with damaged or compromised OE crash structures. OE-Equivalent replacement crash structures are an acceptable substitute.

9.6. SUNROOFS, T-TOPS, CONVERTIBLES

- 9.6.1. All cars with sunroof and/or T-top openings must be covered by either a firmly attached removable hardtop, the original sunroof panel, or a fabricated metal or fiberglass panel secured and fixed in place. Alternately, they can be run as convertibles with the drivers wearing the required arm restraints or with a roof net installed on the vehicle.

9.7. CAR NUMBERS, CLASS DESIGNATION AND VISIBILITY

- 9.7.1. Car Numbers: One, two and three digit numbers are allowed.
- 9.7.2. No cars may use "0" or "00" before their car number.
- 9.7.3. Numbers must be shown on both doors, the front, and rear of the vehicle.
- 9.7.4. Teams may contact their Event Director and arrange for a permanent car number.
- 9.7.5. ALL CARS SHALL USE CHAMPCAR NUMBER BACKGROUND DECALS:

- 9.7.5.1. Two (2) large and two (2) small OFFICIAL CHAMPCAR backgrounds are required. A third large background on the roof (or hood if no roof) is OPTIONAL.
- 9.7.5.2. No other number backgrounds are approved or allowed.
- 9.7.5.3. The required large number backgrounds shall be applied to the front driver and passenger door of the car.
- 9.7.5.4. The required small number backgrounds shall be applied to the front and rear of the vehicle.
- 9.7.5.5. All present number panels must display the same number.
- 9.7.6. ALL CARS SHALL USE BLACK NUMBERS:
 - 9.7.6.1. Numbers shall be at minimum 8.0" tall.
 - 9.7.6.2. Fonts shall be a minimum of 1.0" wide (brush stroke) and a maximum of 1.5" wide.
 - 9.7.6.3. Teams with regional permanent numbers are advised to leave enough room before or after their number to add a simple "1" (or "11") using black duct or electrical tape in case their number has been taken and they are competing out-of-region. All numbers MUST fit within the standard number background.
- 9.7.7. Other than numbers, no other decals, paint, tape or themed item (of any type) are allowed on the ChampCar number background decal.

9.8. CHAMPCAR AND SPONSOR DECALS

- 9.8.1. Each car competing in a ChampCar event shall display the official ChampCar Endurance Series banner at the top of the windshield. The decal must be unobstructed and in clear view. Backgrounds may be any color with the exception of White, Orange, or Yellow. For cars with no windshield, the Event Director will designate an alternate location for the banner.
- 9.8.2. ChampCar will provide teams with other series sponsor logos, printed on a single decal, which must be displayed next to the ChampCar number panels on each side of the car.
- 9.8.3. Other event sponsorship decals may be required.
- 9.8.4. All sponsor decals will be provided at ChampCar Tech Inspection. Reference the BCCR Appendix for installation direction and locations.
- 9.8.5. ChampCar reserves the right to remove any decal that may conflict with ChampCar sponsors, or decals that we find in poor taste.

9.9. HEADLIGHTS, TAILLIGHTS, AND BRAKE LIGHTS

- 9.9.1. All cars must be equipped with suitable headlights. Headlights may be OEM or aftermarket. Cars having more than four (4) light sources mounted on the car, whether working or wired for use, will be required to COMPLETELY REMOVE all lights above the count of four (4).
 - 9.9.1.1. CONVENTIONAL BULBS:
 - 9.9.1.1.1. No single light bulb or light source shall exceed 60W for H3 or H4 bulbs, or 35W for HID bulbs.
 - 9.9.1.1.2. Bulbs must match the housing and lens that they were originally designed for.
 - 9.9.1.1.3. No vehicle may have mounted less than two (2) or more than four (4) headlights. A headlight is defined by the number of illuminating bulbs or sources – not by the housing.
 - 9.9.1.2. LED FIXTURES:

- 9.9.1.2.1. Cars equipped with LED head- or driving- lights shall be restricted to a maximum of 8,000 Lumens. Teams using LED lights MUST have documentation to prove Lumen data.
- 9.9.1.3. Combined Lighting Sources: cars using a combination of BOTH H3/H4/HID and LED lights shall be limited to a maximum of 4,000 Lumens of LED lighting and no more than two lighting sources using conventional H3, H4 or HID lights.
- 9.9.1.4. All headlights must be installed such that the base of the driving light lens is NO HIGHER than six inches (6") above the highest point of the stock front fender and, NO FURTHER BACK than the centerline of the front axle.
- 9.9.1.5. Headlights must be aimed properly, such that all light is directed at track level.
- 9.9.1.6. Cars not meeting these requirements, or with improperly aimed, or blinding lights shall be black flagged and brought in to add, repair, or adjust lights to meet this requirement.
- 9.9.2. Adverse Weather Events: All cars must have minimum of two (2) operational headlights and two (2) operational taillights that remain on during rain/wet/fog/snow weather events, as deemed by ChampCar Officials. Teams will be notified that lights must be switched on.
- 9.9.3. Taillights: All cars must have a minimum of two (2) operational taillights that remain on at all times whenever headlights are on. Taillights may be OEM or aftermarket. No car shall have more than four (4) taillights. Taillight illumination shall be as bright or brighter than a 1034 or 1157 bulb but shall not be so bright as to overpower/ out light operating brake lights. Multi-filament and combination brake/ taillight assemblies are allowed.
- 9.9.4. Brake Lights: Each car must have at least two (2), but not more than four (4) working brake lights that are easily seen from the rear.
- 9.9.5. Rear Rain Lights
 - 9.9.5.1. A rear rain light is recommended but not required.
 - 9.9.5.2. Placement MUST be in the vicinity of the license plate mounting location.
 - 9.9.5.3. Light is only permitted to be used during rain/wet/fog/snow weather.
 - 9.9.5.4. Light is NOT permitted to be used at night.
 - 9.9.5.5. If in use, light must be configured to flash at all times.
- 9.9.6. Headlight and taillight assemblies (and all associated hardware) are considered safety items and do not count toward your car's total points.
- 9.9.7. All glass and/or plastic taillight and brake light lenses that may be damaged from vehicle contact are to be taped over with clear packaging or other strong clear tape. Do not use Scotch tape.
- 9.9.8. Accessory (Theme) Lights:
 - 9.9.8.1. Accessory lights are NOT ADVISED on or inside any wheel assembly (as the lights are often mistaken for sparks).
 - 9.9.8.2. Accessory lights inside the cockpit and driver compartment should be kept to a minimum. If the lighting is determined to be a nuisance to other drivers or race officials, ChampCar shall have the right to order the lights removed or turned off.
 - 9.9.8.3. No accessory lights are to look like or be mistaken for an emergency vehicle. Accessory lights may not blink.

9.10. FUEL SYSTEMS

- 9.10.1. Zero Tolerance for Fuel Leaks. You will have only one chance to repair any fuel leak. If a ChampCar staff member detects a second instance of leakage, regardless of cause, your car will be removed from the race. No exceptions.
- 9.10.2. Total fuel capacity, including all fillers and overflows, shall not exceed the OEM stated fuel capacity for the make/model plus two (2) gallons. This applies to cars equipped with OE fuel tanks and to cars with approved fuel cells.
 - 9.10.2.1. Total fuel capacity may be verified by ChampCar via the drain and fill method. The fuel tank will be completely drained and then refilled with known amounts until fuel escapes the fill port.
- 9.10.3. Surge tanks are limited to 2-Liter (.53-gallons) capacity. Surge tanks do not count towards the total fuel system capacity.
- 9.10.4. Fuel Tanks
 - 9.10.4.1. Stock fuel tanks in stock locations OR approved fuel cells are the only fuel sources allowed for competition.
 - 9.10.4.1.1. Stock fuel tank must not be altered in any way from OEM specifications. No cutting, hammering, ballooning, or other changes are allowed.
 - 9.10.4.1.2. Stock fuel tank vent lines and fill necks may be altered and/or relocated.
 - 9.10.4.2. NON-OEM REPLACEMENT OR SWAPPED FUEL TANKS ARE NOT ALLOWED. It's either stock, in the stock location, or an approved fuel cell with the proper installation.
- 9.10.5. Fuel Cells
 - 9.10.5.1. All fuel cells must have FIA or SFI certification. Fuel cells expire, as outlined in the FIA/SFI certification provided by the manufacturer.
 - 9.10.5.2. All cars equipped with fuel cells MUST have ball-check or sealable breather valves installed on all vents.
 - 9.10.5.3. All cars equipped with fuel cells MUST have roll-over closure or "flapper valves" installed at the fuel inlet port of the fuel cell.
 - 9.10.5.4. ALL FUEL CELLS AND FUEL COMPONENTS MUST BE ENCLOSED IN A METAL CANISTER/ ENCLOSURE.
 - 9.10.5.5. All fuel cells and fuel components (fill tubes, vent lines, etc) shall be separated from the driver compartment by a metal bulkhead. All lines and fittings that pass through the cabin of the vehicle must be metal or must be encased in continuous steel conduit or aluminum tube. The metal canister that makes up the fuel cell does not count as a bulkhead.
 - 9.10.5.6. Rotary-molded (plastic) fuel tanks are allowed as fuel cells provided they are SFI and/or FIA certified, foam filled and fully encased in a metal enclosure, as well as properly installed and supported in the vehicle.
 - 9.10.5.7. Fuel Cell Installation: If you decide to install a fuel cell, it must be securely mounted in a professional manner and must be installed in a safe location. All aftermarket fuel components must use threaded fittings and appropriate hose types, and include all appropriate racecar quality vents, valves, and other features. Fuel cell installation will be judged on overall execution and apparent safety.

- 9.10.5.8. A reasonable protective and supportive square and/or round tubular structures may be installed around any fuel cell PROVIDED that the structure DOES NOT connect to, or tie into any suspension point or suspension pick up point, or add to the general rigidity of the chassis, or provide any performance advantage whatsoever. Fuel cell protective structures may be attached to portions of the main roll cage. Tech Inspection may assess additional points for any structure(s) that violate this rule.
- 9.10.5.9. Fuel cells may be mounted in the passenger floor area of 2-seater cars or cars that have no space behind the driver's compartment, provided:
 - 9.10.5.9.1. The passenger side has full NASCAR type door bars.
 - 9.10.5.9.2. The fuel cell is enclosed by a full metal canister AND a separate bulkhead that encloses the fuel cell and canister. The fuel components (fill tubes, vent lines, etc.) must be separated by a metal bulkhead.
 - 9.10.5.9.3. All lines and fittings that pass through the cabin of the vehicle must be metal or must be encased in continuous steel conduit or aluminum tube.
 - 9.10.5.9.4. The mounting frame and attachments for the fuel cell should be constructed of 1" square or tubular steel, with a minimum wall thickness of 0.120", and tied into the roll cage.
- 9.10.6. Fuel Fillers and Fuel Lines:
 - 9.10.6.1. Vehicles may not have more than the stock number of fill ports.
 - 9.10.6.2. 3" MAXIMUM O.D. for all fuel fill lines.
 - 9.10.6.3. MAXIMUM -8 (AN) or 1/2" I.D. shall be used for all fuel lines from cell/tank to the engine.
 - 9.10.6.4. All fuel lines must be routed in the most direct (shortest distance) path to and from source/termination point.
 - 9.10.6.5. Any fuel, oil, or coolant lines (including Aeroquip steel braided lines) that pass through the driving compartment must be metal or encased in continuous steel conduit or aluminum tube. (Flex conduit is not acceptable. Lines wrapped in aluminum tape are not acceptable.)
- 9.10.7. An overflow tube may be installed. Use of an overflow tube and overflow can DOES NOT remove the requirement for a ground positioned catch pan for spills. If installed, an overflow tube MUST meet the following requirements:
 - 9.10.7.1. Allow passage of vapor and liquid during the fueling process
 - 9.10.7.2. Not allow passage of vapor nor liquid while on track
 - 9.10.7.3. May not extend beyond the protection of the bumper
 - 9.10.7.4. Be constructed of a gasoline resistant hose, no larger than 3/4" (0.75") inside diameter
 - 9.10.7.5. Allow secure attachment of an overflow can with a minimum liquid capacity of 1 gal
 - 9.10.7.6. Overflow can must not be held by a person during fueling
 - 9.10.7.7. Overflow can may not spill fuel upon attachment or removal
- 9.10.8. Fuel Tank Vents allow for passage of vapor, but do not allow for passage of liquid. Fuel Tank Vents are not subject to the restrictions outlined in section 9.10.7.
- 9.11. OIL CATCH TANKS, FILTERS, COOLERS, AND BREATHERS
 - 9.11.1. Non-stock engine, transmission/transaxle, and differential breathers shall be equipped with catch tanks.

9.11.1.1. Minimum catch tank capacity shall be one U.S. quart.

9.11.1.2. Catch tanks shall vent outside the driver's compartment.

9.11.2. Remote oil filters shall NOT be mounted in the driver/passenger compartment.

9.12. COOLANT

9.12.1. Coolant must be water only. Antifreeze or anti-boil is not allowed. Red Line Oil's "Water Wetter" or similar is allowed. A functional 1-Quart minimum capacity catch tank (overflow) is mandatory.

9.13. EXHAUST

9.13.1. A professional installed, quality exhaust system is required.

9.13.2. Exhaust systems must be designed, routed, and maintained to avoid the proximity of fuel tank(s) and/or fuel system components and/or driver compartments.

9.13.3. Exhaust system shall not terminate in front of the main roll-cage hoop.

9.13.4. Exhaust system must include at least two professional quality flexible exhaust hangers behind the collector. All exhaust joints must be properly slip jointed, properly bolted, or welded.

9.13.5. All teams must maintain their exhaust in good condition throughout the event.

9.14. NOISE LIMIT

9.14.1. ChampCar's basic noise limit for ALL EVENTS is 96 dB at 50 feet from the track. Certain events may impose a tighter noise restriction – check all event supplemental rules. Excessive noise will result in a black flag and require repair prior to being readmitted to the race. A second offense will result in disqualification and removal from the event.

9.15. COCKPIT

9.15.1. All loose items in the cockpit must be removed or secured.

9.16. MIRRORS

9.16.1. All cars must have at least one interior mirror. Cars with OE type interior mirrors must also have a driver's side exterior mirror. Passenger's side exterior mirrors are optional. Cars with panoramic or "Wink" type interior mirrors do not require exterior mirrors, however they are optional. A mirror will still be required if an external rear view camera system is used. Any external rear view cameras must be bolted securely within the body lines of the race car.

9.17. ENGINE FIREWALL

9.17.1. Openings or holes in the engine firewall under 2" diameter must be closed and sealed with metal plate or OE type grommets. Fire proof expanded foam fire block should be used around roll bar through openings in any fuel areas, or engine bay areas. Openings larger than 2" diameter must be closed and sealed with metal plate that is bolted, welded, or riveted in place.

9.18. CAMERA MOUNTS

9.18.1. The mounts for video / photographic cameras shall be of a safe and secure design, and confined within the cockpit area of the vehicle. No cameras may be mounted outside of the driver's area or cockpit. The body of the camera (recording unit) shall be securely attached to the roll cage or interior bodywork of the car. Helmet mounted cameras are prohibited.

9.19. COOL SUITS AND DRINKING SYSTEMS

- 9.19.1. Cool suits and drinking systems are allowed in all vehicles. Water tank and/or ice storage container mounts shall be of a safe and secure design. No leakage of any kind is allowed throughout the system. ChampCar will Black Flag your car for any liquid leakage because we won't know if it's cool suit water or gasoline. Driver connections should be quick disconnect or break away.
- 9.19.2. Cool suit coolers will be secured to the chassis using a minimum of a 1" ratcheting type tie-down type strap.

9.20. BALLAST

- 9.20.1. Ballast shall not be added to any car.

9.21. BUMPER BARS / BASH BARS

- 9.21.1. If the factory bumpers are removed from the car, a bar that extends no farther up/down/out/sideways than the factory bumper must be used in its place. The bar must attach to/cover the factory frame rails.

9.22. AERODYNAMIC DEVICES

- 9.22.1. Aerodynamic devices not to exceed width of unmodified OE bodywork (fenders, bumpers, doors). Note: Side mirrors are not included in bodywork width. Maximum wing height 12" above roof. Maximum wing drop-back 12" behind car. A splitter is any horizontal device installed from the centerline of the front axle extending a maximum of 12" out of the front of the vehicle. An air dam is any vertical device installed from the nose of the bumper down.
- 9.22.2. Wings may not be mounted forward of the centerline of the rear axle.
- 9.22.3. Moving aerodynamic devices are prohibited.
- 9.22.4. Definition of a 10 point wing: Uprights (mounts), Endplates, and a single airfoil. A Gurney flap is permitted.

APPENDIX 1 – AERODYNAMIC ANATOMY

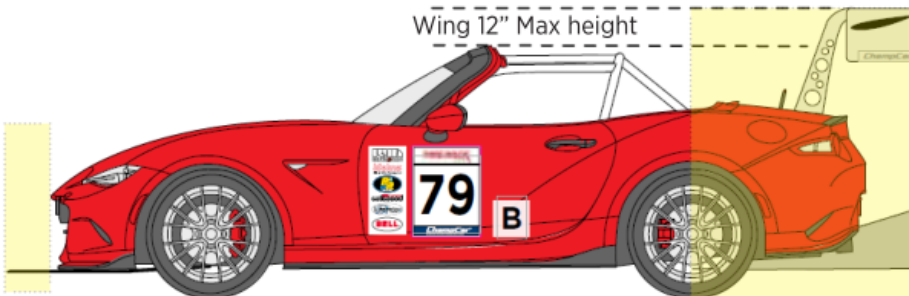
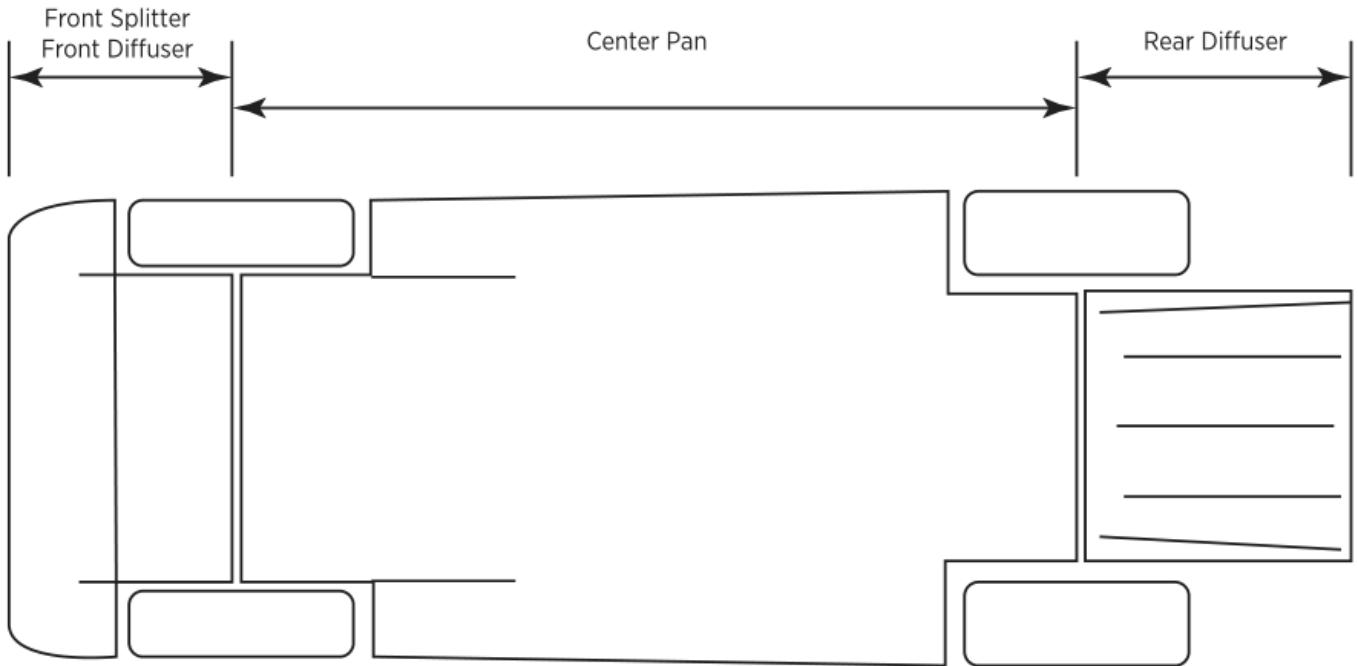

12" max in front of bumper.

Allowed area for front aero devices. Front wings not allowed per the BCCR.

Allowed area for rear aero devices

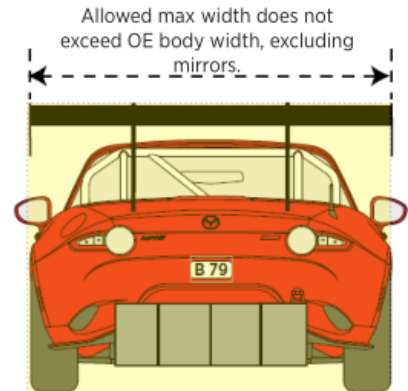

Aero devices may extend out the back of the car a maximum of 12" from the rear bumper.

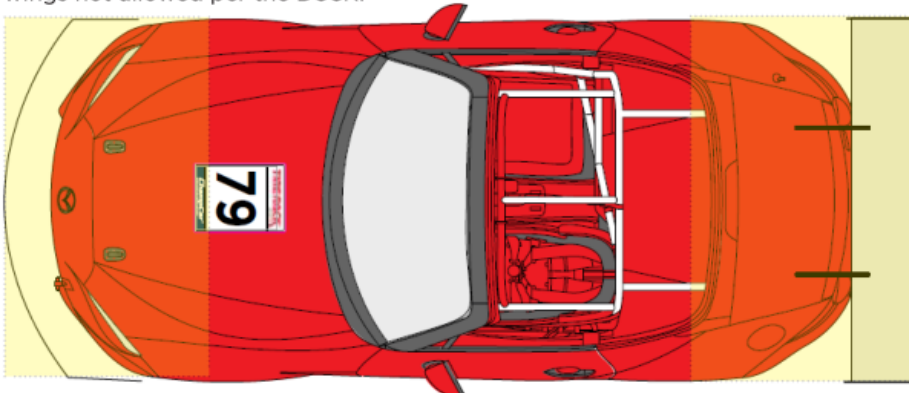

APPENDIX 2 – CHASSIS MODIFICATION GUIDE

The front hood and trunk lid/hatchback can be removed.

Chassis frame rails must use the same material type and general shape as OE.

Front fenders may be modified. Overall length cannot be altered above the wheel.

The trunk floor must be in place. A fuel cell may be inset into the floor, if equipped. The spare tire well may be removed.

The bumper must be mounted to the ends of the frame rail and be of the same general height as the OE bumpers.

The rear body panel must be in place between the rear quarter panels.

The rear quarter panels from the rear window location down must maintain the general profile of a standard stock side view of the car. Overall length cannot be altered above the wheel.

At ChampCar's sole discretion, any car may be determined unsafe for competition and may be removed from the event at any time.

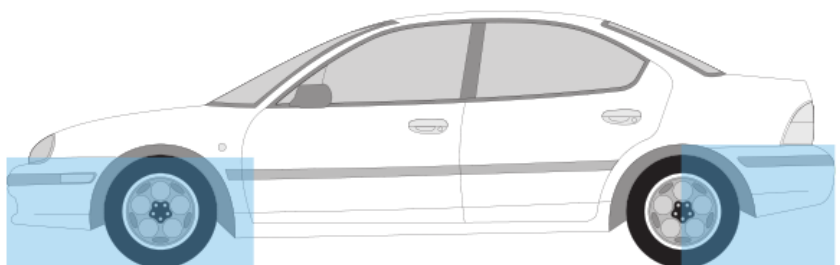
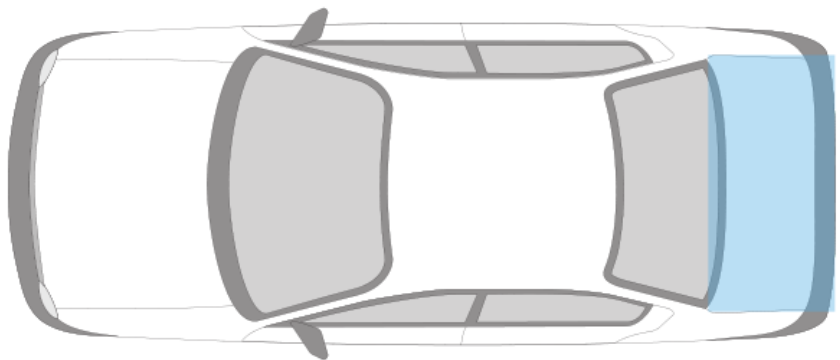
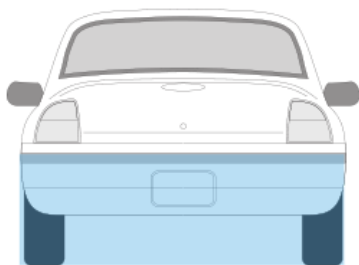

APPENDIX 3 – LEGAL

I) General

- a) Right of Publicity: All participating cars, drivers, crew members and guests may be photographed, videotaped, recorded, or quoted, and by entering, attending and/or participating in any ChampCar event, you grant ChampCar the right to the use of such images and/or recordings including but not limited to use on television, Internet, within various publications and/or any other analog-digital broadcast or print media.
- b) Any known medical condition (including pregnancy) which could affect medical fitness to compete shall be reported and identified on the event entry application. Any significant change in medical status from the date the entry has been submitted until and up to the start of the event, including cardiac or neurological problems, such as heart attack, heart surgery, strokes, seizures, any major surgery or diagnosis of cancer must be reported to the Event Director prior to that driver entering the track.
- c) Each competitor and crew member is encouraged to have someone in their team maintain medical information about them in the event it may be needed by a medical treatment team. A driver who is involved in an accident in which his or her car rolls over, collides with a stationary object hard enough to cause structural damage to his or her car, who is aware of possible injury from an accident, or who is directed to obtain medical attention by an official shall report to the Event Director of the event as soon as possible.
- d) A driver, crew member, official or staff worker/ volunteer at an event that is transported off-site to a medical facility shall not subsequently compete in or engage in any further activity at that event and may not enter any other ChampCar event without presenting a medical release signed by their personal physician.
- e) A driver, crew member, official or staff worker/ volunteer who suffers loss of consciousness shall not subsequently compete in or engage in any further activity at that event and may not enter any other ChampCar event without presenting a medical release signed by their personal physician.

II) Entries and Teams

- a) The organizers have the right to refuse an entry at their discretion without giving a reason for refusal. If an entry for any competition is refused, notification of such refusal shall be sent to the entrant at the e-mail address given on the Entry Form as soon as possible.
- b) An entry which contains a false or incorrect statement may be determined to be null and void by ChampCar. The entrant may be deemed guilty of a breach of the BCCR, the entry fee may be forfeited, and further penalties may be imposed.

III) Children & Pets:

- a) Parents or guardians of any minor shall be fully responsible for actions of their children. At SOME tracks children under the age of eighteen (18) MAY be allowed in the paddock or cold pit lane, under supervision by an adult. However, SOME tracks do not allow children in a cold pit lane. Each event's Supplemental Rules shall state the track's and/or event's policy for children on COLD pit lane. Children are prohibited in the HOT pit lane, even with an adult. Any person signing an event waiver for a minor shall be held responsible for that minor. Children under the age of 16 are not allowed to drive any motorized- or gasoline-powered vehicle in the paddock or garage area at any racetrack. That includes golf carts, scooters, ATV's, etc.
- b) Pet owners shall be fully responsible for actions of their pets. When track rules permit, a pet may be in the paddock, provided it is enclosed in a vehicle or on a leash that does not exceed six feet (6') in total length. When a pet is on a leash, it shall be controlled by an adult. Pets are prohibited in the pits. Pet owners are responsible for contacting the track to inquire about pet access and specific track rules. Track rules on pets shall always supersede ChampCar rules on pets.

APPENDIX 4 – BELT INSTALL

SEATBELT INSTALLATION GUIDE FOR UPRIGHT SEATING (UP TO 25° RECLINE SEAT BACK ANGLE)

***IMPORTANT NOTICE:** The purpose of this guide is to provide motorsports vehicle drivers, owners and mechanics with additional information on seatbelt installation. This guide is for informational purposes only and in no way should it be construed to be an express or implied warranty of safety or guarantee that Driver Restraint Systems mounted in accordance with this guide will prevent any injury, systems failure, property damage, or death. Participation in motorsports carries with it the risk of serious injury, property damage and death at all times regardless of which driver restraint systems are used. This informational guide does not supersede or replace product manufacturers' installation instructions or sanctioning body rules and requirements. This guide applies to Driver Restraint Assemblies which pertain to the SFI Specification 16.1 and SFI Specification 16.5 compliance programs. Prior to any seatbelt installation or installation modification, consult with the motorsports vehicle builder, seatbelt manufacturer, and sanctioning body. At all times the driver and vehicle owner have prime responsibility for the safe installation and use of seatbelts.

SHOULDER BELTS

Shoulder Belt Angle: 0 to -20° (-10° optimum) from horizontal

- Clear passage of webbing from top of shoulder (or head and neck restraint) back to the harness bar or mounting point without any interference of the seat openings
- Belts should be as short as possible back to the mounting points

Double Shoulder Belt (Over/Under Belt):

- Upper belt (2" belt) 0 to -10° (-10° optimum)
- Body belt (3" belt) -10 to -30° (-20° optimum)
- Separation between upper and lower belt 1" to 2"
- Upper belt mounted to line up with the inside edge (closer to the neck) of the Body belt.

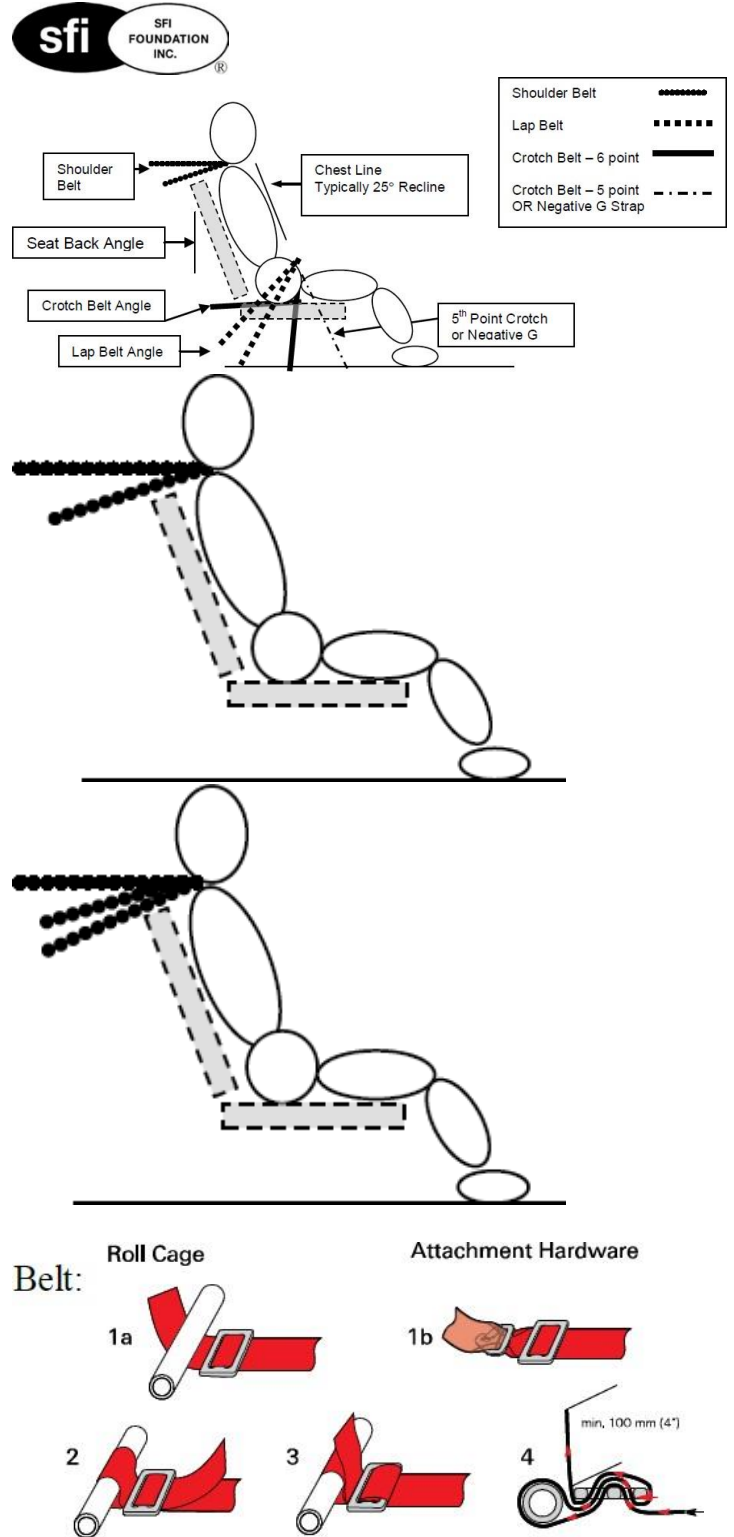

LAP BELTS

Lap Belt Angle: -45° to -80° from the horizontal

- Belt should ride within the curvature of the pelvic bone preferably just below the iliac crest
- There should be clear passage through the seat opening without webbing being corded or binding on edges of seat openings with a direct path to the mounting point
- The webbing should not ride against any hardware such as seat mounting brackets, bolts, or tabs
- Lap belt adjusters should be clear of the seat openings. Pull-up adjusters if outside the seat opening should be a minimum of 2" below the opening when the lap belt is tightened
- Belts to the mounting point should be as short as possible mounted beside the seat and never behind the seat
- Lap belt should be allowed to pivot freely at the mounting point
- Webbing should be allowed to pull on hardware in plane (straight)
- Position of the Cam Lock or Latch and Link
- Centered on the body 1 to 2 inches below the belly button when all belts are tightened

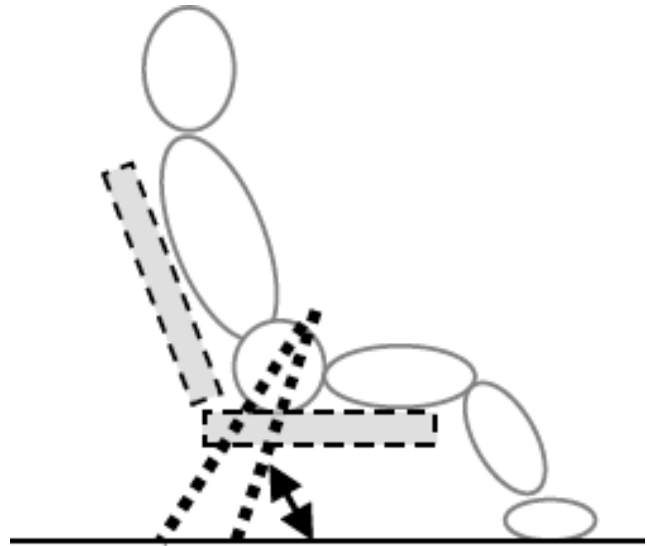

CROTCH BELT – 6 POINT

Sports Car “Shell Type Seat” and aluminum seats with single crotch belt hole forward of the inside seat back from 10 to 12 inches: (NOTE: Seats with a single hole positioned more than 12 inches from the inside seat back are designed for 5-point belt installations and may not be as effective for 6-point installations):

- Crotch Belt Angle: -20° ($2''$ rearward) through the hole
- Two separate anchors 4 to 6 inches apart
- Containment Seats with Crotch belt mounting directly to seat bottom OR through holes provided at the back of the seat bottom: (Driver is sitting on the Crotch belts)
- Crotch Belt Angle -10° to -20° from the perpendicular just in front of the crotch with anchors 4 to 6 inches apart

OR:

- Crotch Belt Angle Horizontal rearward to under the butt or to the back of the seat
Option (typically for single-seat wide cockpits): Crotch Belt mounting to the front side of the outboard lap anchors. (Option not illustrated)
- Considerations:
Routing of crotch belts should have a clear and unobstructed path to the mounting point

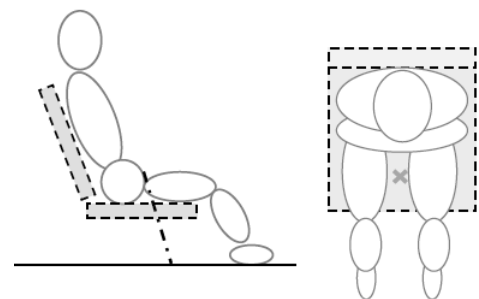
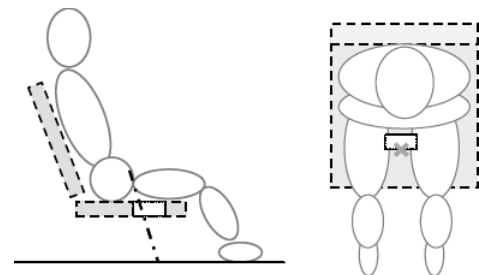
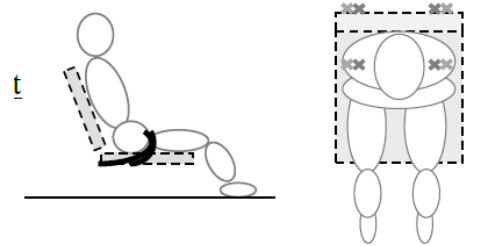
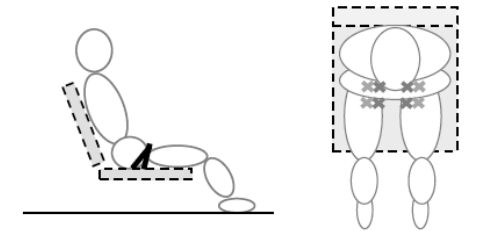
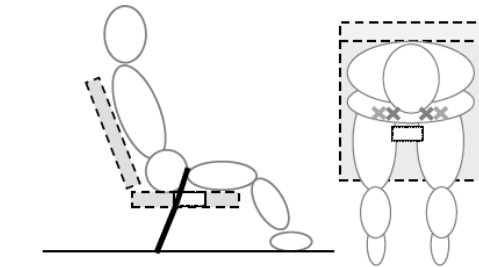

CROTCH BELT – 5 POINT

Sports Car “Shell Type Seat” and aluminum seats with single crotch belt hole forward of the inside seat back from 11 to 13 inches:

- Crotch Belt Angle: Chest line to 20° through the hole
- Crotch Belt should never wrap around the front of the seat – there should be a pass through
- Crotch belt is used only to maintain position of the lap belt

NEGATIVE G BELT (7TH POINT)

- Negative G Strap Angle: 20° to 25° (Chest line extension on a 25° seat back angle)
- Used in conjunction with a 6-point crotch belt system as an additional point to maintain the position of the lap belt in “Negative G” i.e. rollovers.

APPENDIX 5 – ROLL CAGE

Please visit <https://champcar.org/web/rules.php#cage> for a 3D interactive view of the cage.

All views are for left hand drive vehicles. Reverse for right hand drive vehicles.

Please visit <https://champcar.org/tech> to ask questions about safety equipment and cages.

Basic “NASCAR” Style Door Bar Roll Cage

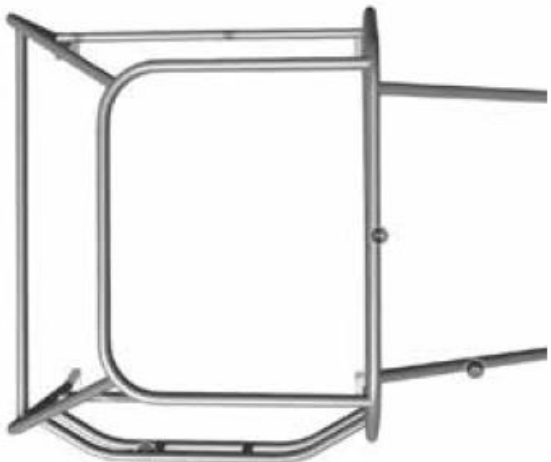

Basic “X-Bar” Style Door Bar Roll Cage



Tech Tip:

After the cage has cooled, take an inspection mirror, a small flashlight, and your finger, and inspect all welds. Visually look for missing welds, and run your fingers across the welds to find missing filler. Tech inspectors will also do this on all welds.

Areas that are blocked from welding, may require drilling or cutting access holes in the roof or body to get the weld tip access to the area that needed welded.

Contact Roll Cage Components for cage supplies or full cage builds.

<https://rollcagecomponents.com/champcar-endurance-roll-cage-kit>

Use taco or tab gussets to increase the strength and stiffness of the cage.

APPENDIX 6 – DECAL PLACEMENT



Decal Installation & Location Instructions

Per the BCCR. The following examples are approved installation locations for the required ChampCar decal package.



Sponsor and number panels must be attached between the arrows as shown. Sponsors may be cut out of the white background but must remain in the same order and be applied in the vertical style as shown. It would be best to plan your graphic style around the number/sponsor panel placement. Per the BCCR, numbers on all number panels shall be black and at minimum 8.0" tall. Fonts shall be a minimum of 1.0" broad (brush stroke) and a maximum of 1.5" wide.

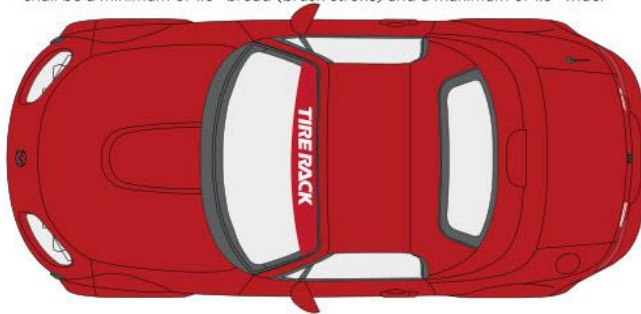

A roof/hood number panel may still be used, but are no longer required. Per the BCCR, numbers on all number panels shall be black and at minimum 8.0" tall. Fonts shall be a minimum of 1.0" broad (brush stroke) and a maximum of 1.5" wide.



TireRack retains exclusive rights to placement at the top of the windshield region. No additional text or logos are permitted within a 6-inch range above or below the TireRack name. While the background is discretionary, it should not be white, orange, or yellow as specified by the BCCR. The TireRack letters must be in white. Vehicles lacking front windshields are required to display a decal at the top of the hood. The TireRack letter size should be 100mm/4" tall, and their orientation can be adjusted to suit the curvature of the windshield.

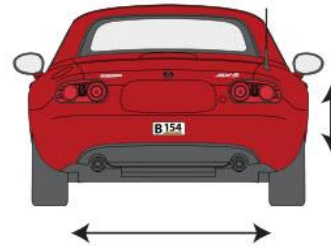

Class/Number bumper decal must be attached to the car's front and rear as shown between the arrows. For the front decal, pick a place facing forward.



All decals shown on the left image must be applied to your ChampCar before you tech the car and start the race event. Teams may use a ChampCar supplied white die-cut TireRack window decal. Any missing decals can delay the start of your race.

ChampCar Tech will have a limited number of blank number panels for sale along with free sponsor panels, TireRack window die-cut banners, class letter decal, and a blank rear bumper class decal.

The number panel design will allow you to remove the top and lower Sponsor/ChampCar sections if you race with other sanctioning bodies. Just visit tech when you return to ChampCar to get new upper and lower patch panels for the number panel for free.

Order decal packages with printed numbers at <https://rvagfx.com/store>
Please allow 3-4 weeks before your event as shipping may be slow.
Don't wait until the last minute to order.

APPENDIX 7 – TRANSPONDER

An AMB 260X or AMB /MyLaps X2/MyLaps TR2 transponder is required to compete. You can bring your own, or rent one from ChampCar.

Rental transponders must have a factory MyLaps / AMB transponder mounting bracket affixed to their car in an approved location. Mounts are sold by ChampCar at tech inspection. No loose or zip-tied or duct-taped transponders are allowed.

If a rental transponder is lost or broken, you agree to be charged for its replacement. If the case is cracked or deformed in any way but the unit still works, you agree to be charged for repair and testing.

Transponder Mounting Tips:

- Always mount the transponder so that the black (AMB260X) or red (MyLaps TR2) is to the ground (not sideways).
- You need to get a bracket (they're only \$10 and hold a \$500+ unit in place).
- Do not mount it anywhere near the exhaust as the unit will melt.
- Put in a safe place where it will not get destroyed if someone "rubs" you.
- There should be a clear line of sight top the ground with no objects between the transponder and the ground.
- DO NOT cut a hole in the floorboard.
- It is best to mount the transponder on the engine bay frame rail (away from hot exhaust headers/ turbo) or near the fuel cell/ tank.
- Installation height should be between 10" - 14" off the ground.
- DO NOT mount to bumpers, spoilers, areas that can easily be damaged.
- DO NOT mount using duct tape, zip ties, or wet chewing gum.
- DO NOT just throw in the floor board, the door channel, or in your drivers pockets.

If you entered a transponder number (or entered anything really) while you were registering we assume you're bringing your own. Please verify that you have entered the correct number or that you reserved a transponder if you're not supplying your own. If you use a subscription based MyLaps X2 / MyLaps TR2 transponder, make sure your subscription is current. When your subscription ends, the X2/TR2 will not count laps



Activation of the AMB TR2 requires the downloading of the Speedhive App.



HITS

MyLaps TR2 Mounting Recommendations



Transponder mounting distance from mount to track surface.

There MUST be clear line of sight between the black part of the transponder and the racing track surface.

This is the top



This is the bottom

APPENDIX 8 – FLAGS

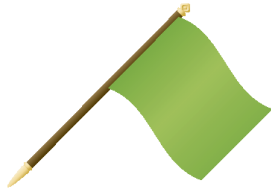

Green
Start of race/End of Caution



White Flag
Slow moving vehicle and/or emergency vehicle ahead.



White w/ CrossFlag
Emergency vehicle on track.

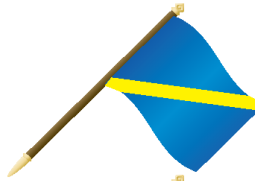

Blue / Yellow Flag
Faster car behind you, hold your line.



Blue Flag
FIA tracks may use this instead of Blue/ Yellow. Faster car behind you, hold your line



Meatball Flag
Return to pitlane. Something is wrong with your car.

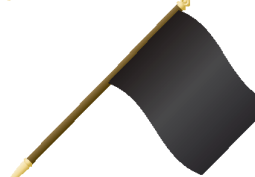

Black Flag
Come to pitlane now, We would like to talk to you.



Checkered Flag
You have survived. Complete your cooldown lap and return to pitlane.

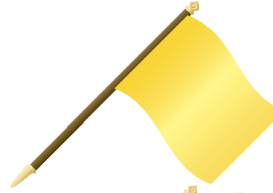

Yellow Flag
Local yellow. Slow, no passing. Something is dangerous ahead.



Yellow / White Flag
Local yellow. Slow, no passing. Something is dangerous ahead. EV on track.



Double Yellow Flag
Full course caution. No passing anywhere.



Code 35 Flag
Maintain 35 mph. No passing. Maintain interval between you and the car ahead. Used where applicable.



Debris Flag
Slippery track surface or debris on track.



Red Flag
Come to controlled stop where you can see the next cornerworker. Obey corner worker instructions.



Racing flags are used in auto racing to indicate track condition and to communicate important messages to drivers. Typically, the starter waves the flags atop a flag stand near the start/finish line. Track marshals are also stationed at observation posts along the race track in order to communicate both local and course-wide conditions to drivers. Alternatively, some race tracks employ lights to supplement the flags at the start/finish and around the course, especially during night racing.

©2023 ChampCar Endurance Series

APPENDIX 9 – FLAGTRONICS

- Flagtronics FT200 Installation
 - Flagtronics FT200 units MUST be securely mounted to a rigid structure
 - The GPS antenna requires a clear line of sight to the sky
 - Teams are responsible for ensuring the FT200 has an adequate power source, and that the FT200 stays on during a pit stop utilizing the battery built into the cable
 - Teams are responsible for entering the FT200 unit serial number into the registration system when registering the car for a race
- Flagtronics FT200 Location
 - The FT200 should be mounted to the right of the steering wheel
 - Within approx. 15in above the vertical centerline of the steering wheel
 - Within approx. 15in of the horizontal centerline of the steering wheel
 - All drivers of the car should be able to reach the device while belted



Following the above guidelines ensures a clear view of the FT200 by the driver along with a line of sight to the device by ChampCar pit-lane staff, ensuring efficient release onto the circuit.

CHAMPCAR MISSION STATEMENT



ChampCar exists to give people a simple path to start road racing.
Real racing, wheel to wheel on Americas greatest road courses.

But it has to be a hobby that is attainable for the average person. By offering racing in an endurance format, teams can be utilized and the cost can be shared between 2 or more drivers. Our rule book is unique and while sometimes controversial, it exists to keep a cap on the amount of money and speed required to race with us.

In ChampCar we have seen all types of drivers race with us: from completely new to the sport to veteran pro racers. We believe that experience is the best teacher and that you will get all the experience you will need in one of our endurance events.

© 2009-2024 ChumpCar International Inc., All rights reserved. ChampCar Endurance Series, ChampCar, CCES, and ChampCar.Live, are trademarks and /or service marks of ChumpCar International Inc..The ChampCar logo is a service mark of the ChumpCar International, Inc. and is fully protected.